



The information in this document is subject to change without notice and should not be construed as a commitment by ABB. ABB assumes no responsibility for any errors that may appear in this document.

Except as may be expressly stated anywhere in this document, nothing herein shall be construed as any kind of guarantee or warranty by ABB for losses, damages to persons or property, fitness for a specific purpose or the like.

In no event shall ABB be liable for incidental or consequential damages arising from use of this document.

This document and parts thereof must not be reproduced or copied without ABB's written permission, and contents thereof must not be imparted to a third party nor be used for any unauthorized purpose. Contravention will be prosecuted.

Additional copies of this document may be obtained from ABB at its then current charge.

© Copyright 2019 ABB ALL right reserved.

ABB

SE-721 68 Västerås
Sweden

Latest revision: ECO 105331, WI 241451
Pg 50-55: Functional earth added.
Pg 104-105; 155-157; 204-205: New harnesses added,
including functional earth.

Prepared by, date: EM 2019-06-26 | Approved by, date: ML 2019-08-14



Lab/Office:
RARO SE
RDM2

IRB6650S, IRB7600 LeanID

COPYRIGHT PAGE

DRESS PACK

Status: 2019-08-14

Approved

Document no.

3HAC022327-002

Plant: = SP
Location: +
Sublocation: +

Rev. Ind
01

Page 1
2
Total 31

We reserve all rights in this document and in the information contained therein. Reproduction, use or disclosure to third parties without express authority is strictly forbidden. © Copyright 2003 ABB

Table of contents

ABB_table_of_contents

Plant	Location	Sublocation	Page	Page description	Page supplementary field	Date	Editor
SP			1	COPYRIGHT PAGE	APPROVED	2015-09-03	SEEMFJA
SP			2	TABLE OF CONTENTS 1-271	APPROVED	2015-09-03	SEEMFJA
SP			3	LEGEND	APPROVED	2015-09-03	SEEMFJA
SP	S		50	BLOCK DIAGRAM - TYPE S	APPROVED	2019-08-14	SEERMES
SP	Se		51	BLOCK DIAGRAM - TYPE Se	APPROVED	2019-08-14	SEERMES
SP	H		52	BLOCK DIAGRAM - TYPE H	APPROVED	2019-08-14	SEERMES
SP	HS		53	BLOCK DIAGRAM - TYPE HS	APPROVED	2019-08-14	SEERMES
SP	HSe		54	BLOCK DIAGRAM - TYPE HSe	APPROVED	2019-08-14	SEERMES
SP	CON		55	CONNECTOR LAYOUT	APPROVED	2019-08-14	SEERMES
SP	CON		56	CONNECTOR LAYOUT	APPROVED	2015-09-03	SEEMFJA
DP	S	AX3	100-101	PARACOM SW6	APPROVED	2015-09-03	SEEMFJA
DP	S	AX3	102-103	PARABUSCOM SW6	APPROVED	2015-09-03	SEEMFJA
DP	S	AX3	104-105	PARAMULTI SW6	APPROVED	2019-08-14	SEERMES
DP	Se	AX3	150-151	PARACOM, SERVOGUN SW6	APPROVED	2015-09-03	SEEMFJA
DP	Se	AX3	152-154	PARABUSCOM, SERVOGUN SW6	APPROVED	2015-09-03	SEEMFJA
DP	Se	AX3	155-157	PARAMULTI, SERVOGUN SW6	APPROVED	2019-08-14	SEERMES
DP	H	AX3	200-201	PARACOM MH3 & 6	APPROVED	2015-09-03	SEEMFJA
DP	H	AX3	202-203	PARABUSCOM MH3 & 6	APPROVED	2015-09-03	SEEMFJA
DP	H	AX3	204-205	PARAMULTI MH3 & 6	APPROVED	2019-08-14	SEERMES
DP	PG		250	PEDISTAL GUN	APPROVED	2015-09-03	SEEMFJA

We reserve all rights in this document and in the information contained therein. Reproduction, use or disclosure to third parties without express authority is strictly forbidden. © Copyright 2003 ABB

We reserve all rights in this document and in the information contained therein. Reproduction, use or disclosure to third parties without express authority is strictly forbidden. © Copyright 2003 ABB

1	2	3	4	5	6	7	8
Paracom	Parallel Communication					Protective Earth	
Parabuscom	Parallel and Bus Communication (CANBUS, PROFIBUS and DEVICENET)					Twisted wires	
Paramulti	Parallel and Ethernet Communication					Quad twined wires	
S	Welding					Screened wires	
Se	Weld with Servogun					Screen is connected to earth	
H	Material Handling					Screen connection continues on the next page	
FB	Motor Feedback Signal (7th axis)						
SMB	Serial Measurment Board						
CP/CS	Customer Power/Customer Signal						
CBUS	Bus Signal						
SP	Servo Gun Signal						
MH3	Harness between axis 3 to axis 6						
MH6	Harness between Manipulator base to axis 6						

BLOCK DIAGRAM TYPE S (pneumatic gun)
 IRBDP SW6
 Single cabinet controller, IRC5: See circuit diagram, 3HAC024480-011
 and 3HAC026871-020 for Panel mounted controller.
 Dashed cables: See circuit diagram SpotPack, 3HAC026208-001

* Functional earth exist only on the option Paramulti.

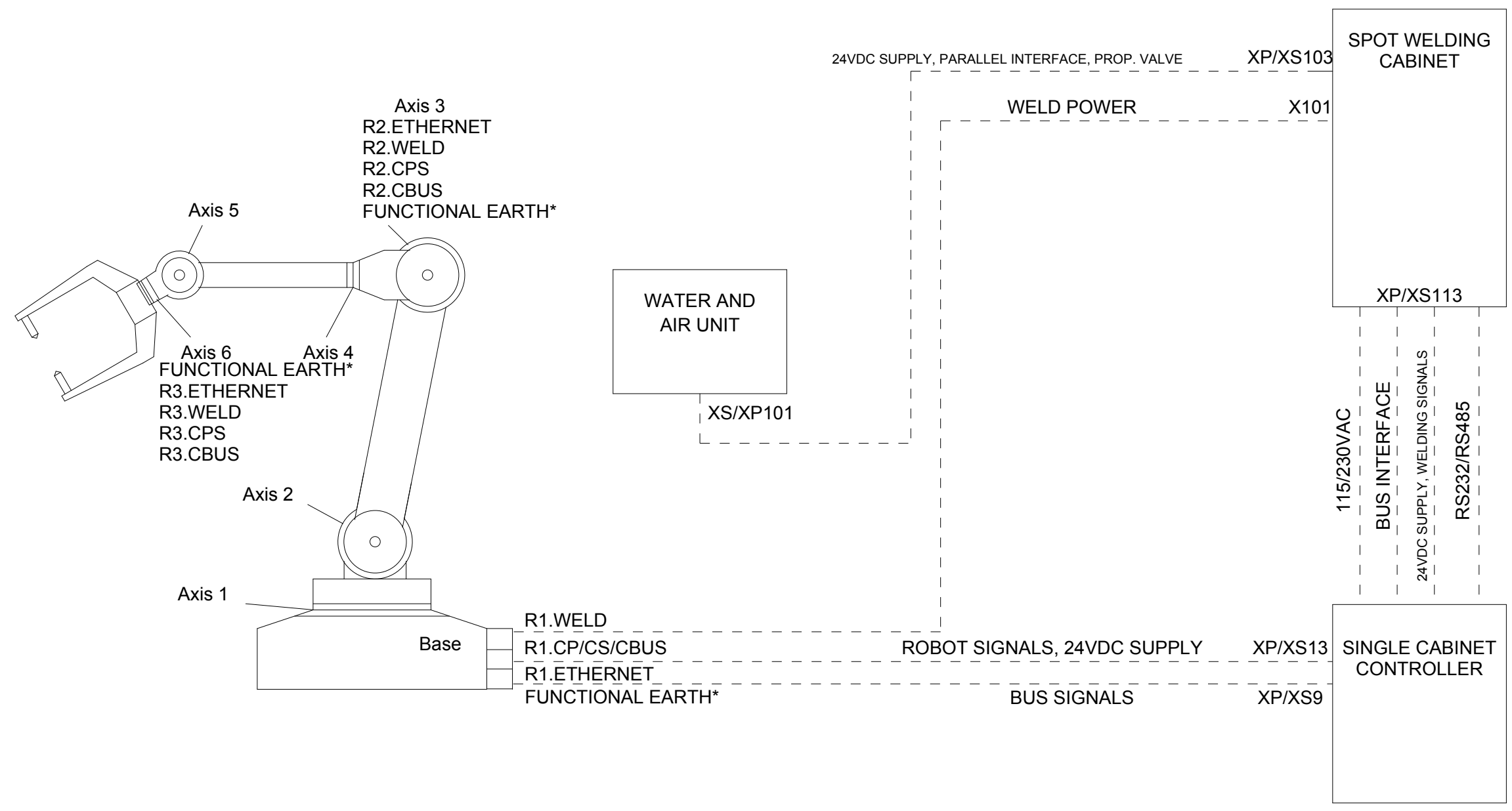

We reserve all rights in this document and in the information contained therein. Reproduction, use or disclosure to third parties without express authority is strictly forbidden. © Copyright 2003 ABB

Latest revision: ECO 105331, WI 241451
 Pg 50-55: Functional earth added.
 Pg 104-105; 155-157; 204-205: New harnesses added,
 including functional earth.

Prepared by, date: EM 2019-06-26 | Approved by, date: ML 2019-08-14



Lab/Office:
 RARO SE
 RDM2

IRB6650S, IRB7600 LeanID
 BLOCK DIAGRAM - TYPE S
 DRESS PACK

Status: 2019-08-14	Plant: = SP
Approved	Location: + S
Document no. 3HAC022327-002	Sublocation: +
Rev. Ind 01	Page 50
	+Se/51
	Total 31

BLOCK DIAGRAM TYPE Se (servo gun)
 IRBDP SW6
 Single cabinet controller, IRC5: See circuit diagram, 3HAC024480-011
 and 3HAC026871-020 for Panel mounted controller.
 Dashed cables: See circuit diagram SpotPack, 3HAC026208-001

* Functional earth exist only on the option Paramulti.

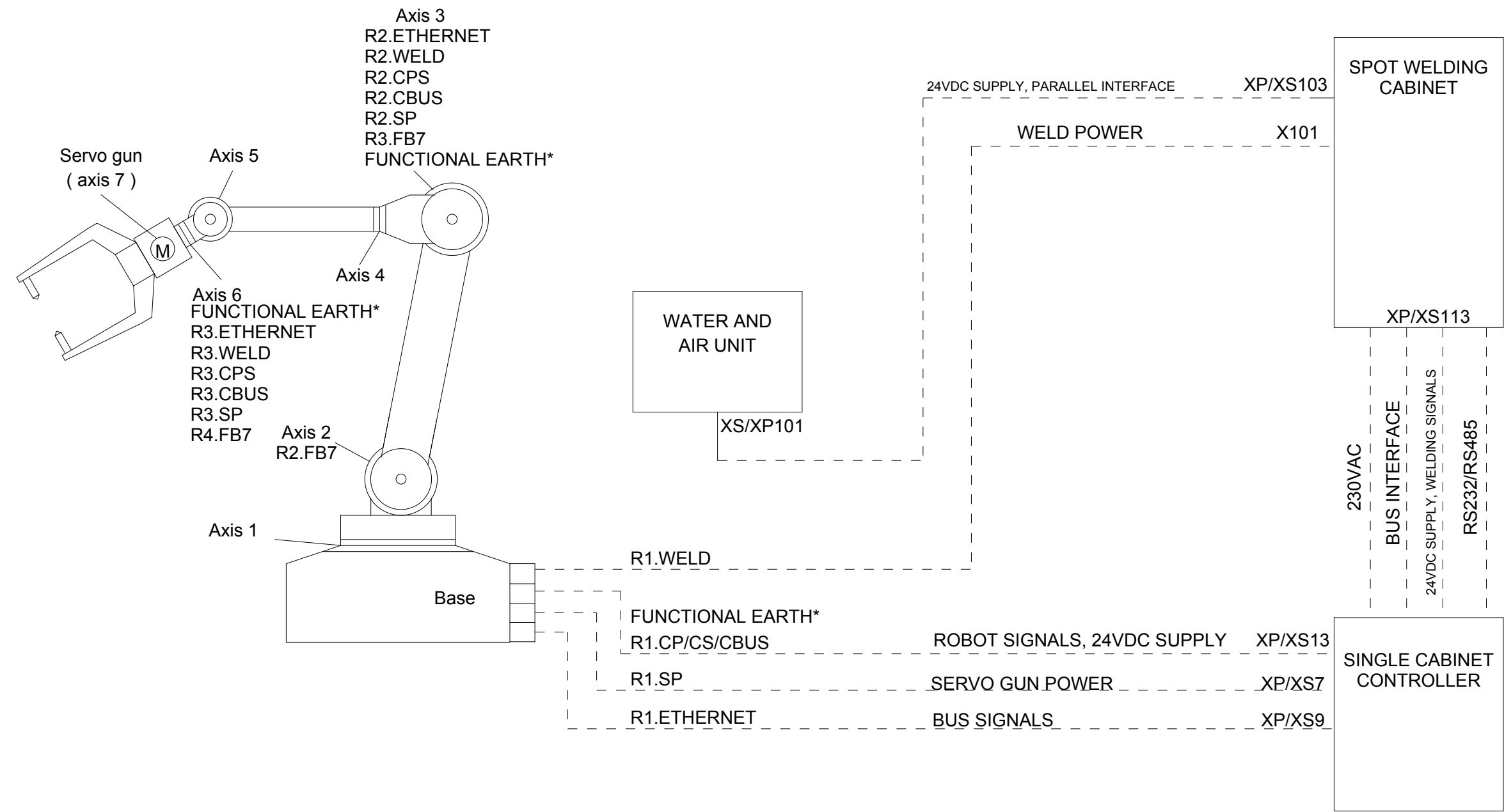

We reserve all rights in this document and in the information contained therein. Reproduction, use or disclosure to third parties without express authority is strictly forbidden. © Copyright 2003 ABB

Latest revision: ECO 105331, WI 241451
 Pg 50-55: Functional earth added.
 Pg 104-105; 155-157; 204-205: New harnesses added,
 including functional earth.

Prepared by, date: EM 2019-06-26 | Approved by, date: ML 2019-08-14

ABB Lab/Office:
 RARO SE
 RDM2

IRB6650S, IRB7600 LeanID
 BLOCK DIAGRAM - TYPE Se
 DRESS PACK

Status: 2019-08-14
 Approved
 Document no. 3HAC022327-002
 Rev. Ind 01
 Page 51
 +H/52
 Total 31

Plant: = SP
 Location: + Se
 Sublocation: +

BLOCK DIAGRAM TYPE H

IRBDP SW6
 Single cabinet controller, IRC5: See circuit diagram, 3HAC024480-011
 and 3HAC026871-020 for Panel mounted controller.

* Functional earth exist only on the option Paramulti.

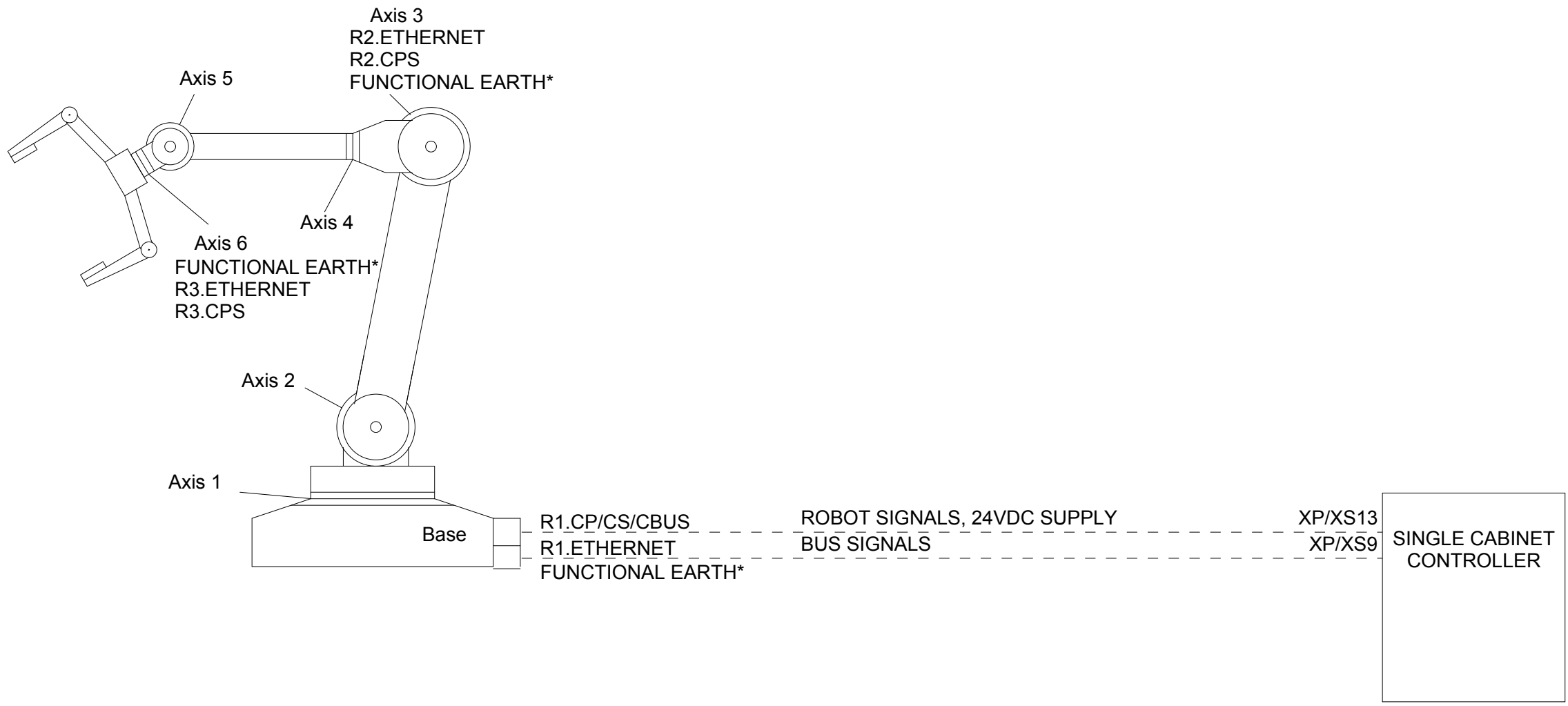

We reserve all rights in this document and in the information contained therein. Reproduction, use or disclosure to third parties without express authority is strictly forbidden. © Copyright 2003 ABB

Latest revision: ECO 105331, WI 241451
 Pg 50-55: Functional earth added.
 Pg 104-105; 155-157; 204-205: New harnesses added,
 including functional earth.

Prepared by, date: EM 2019-06-26 | Approved by, date: ML 2019-08-14



Lab/Office:
 RARO SE
 RDM2

IRB6650S, IRB7600 LeanID
 BLOCK DIAGRAM - TYPE H
 DRESS PACK

Status: 2019-08-14
 Approved
 Document no. 3HAC022327-002

Plant: = SP
 Location: + H
 Sublocation: +

Rev. Ind 01
 Page 52
 +HS/53
 Total 31

BLOCK DIAGRAM TYPE HS (material handling and pneumatic gun)
 IRBDP SW6
 Single cabinet controller, IRC5: See circuit diagram, 3HAC024480-011
 and 3HAC026871-020 for Panel mounted controller.
 Dashed cables: See circuit diagram SpotPack, 3HAC026208-001

* Functional earth exist only on the option Paramulti.

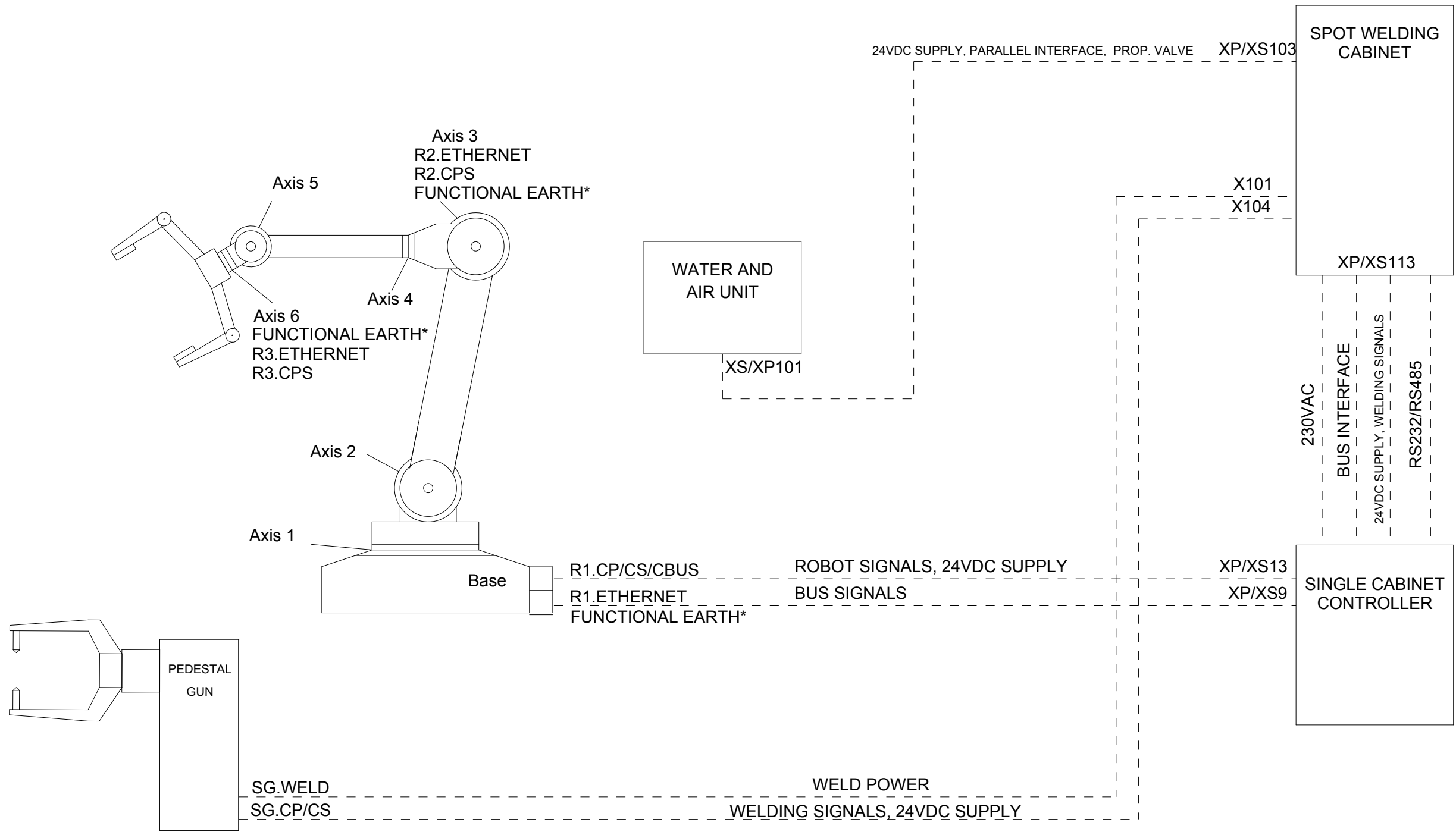

We reserve all rights in this document and in the information contained therein. Reproduction, use or disclosure to third parties without express authority is strictly forbidden. © Copyright 2003 ABB

Latest revision: ECO 105331, WI 241451
 Pg 50-55: Functional earth added.
 Pg 104-105; 155-157; 204-205: New harnesses added,
 including functional earth.



Lab/Office:
 RARO SE
 RDM2

IRB6650S, IRB7600 LeanID
 BLOCK DIAGRAM - TYPE HS
 DRESS PACK

Status: 2019-08-14
 Approved
 Document no. 3HAC022327-002
 Plant: = SP
 Location: + HS
 Sublocation: +
 Rev. Ind 01
 Page 53
 +HSe/54
 Total 31

Prepared by, date: EM 2019-06-26 | Approved by, date: ML 2019-08-14

BLOCK DIAGRAM TYPE HSe (material handling and servo gun)
 IRBDP SW6
 Single cabinet controller, IRC5: See circuit diagram, 3HAC024480-011
 and 3HAC026871-020 for Panel mounted controller.
 Dashed cables: See circuit diagram SpotPack, 3HAC026208-001

* Functional earth exist only on the option Paramulti.

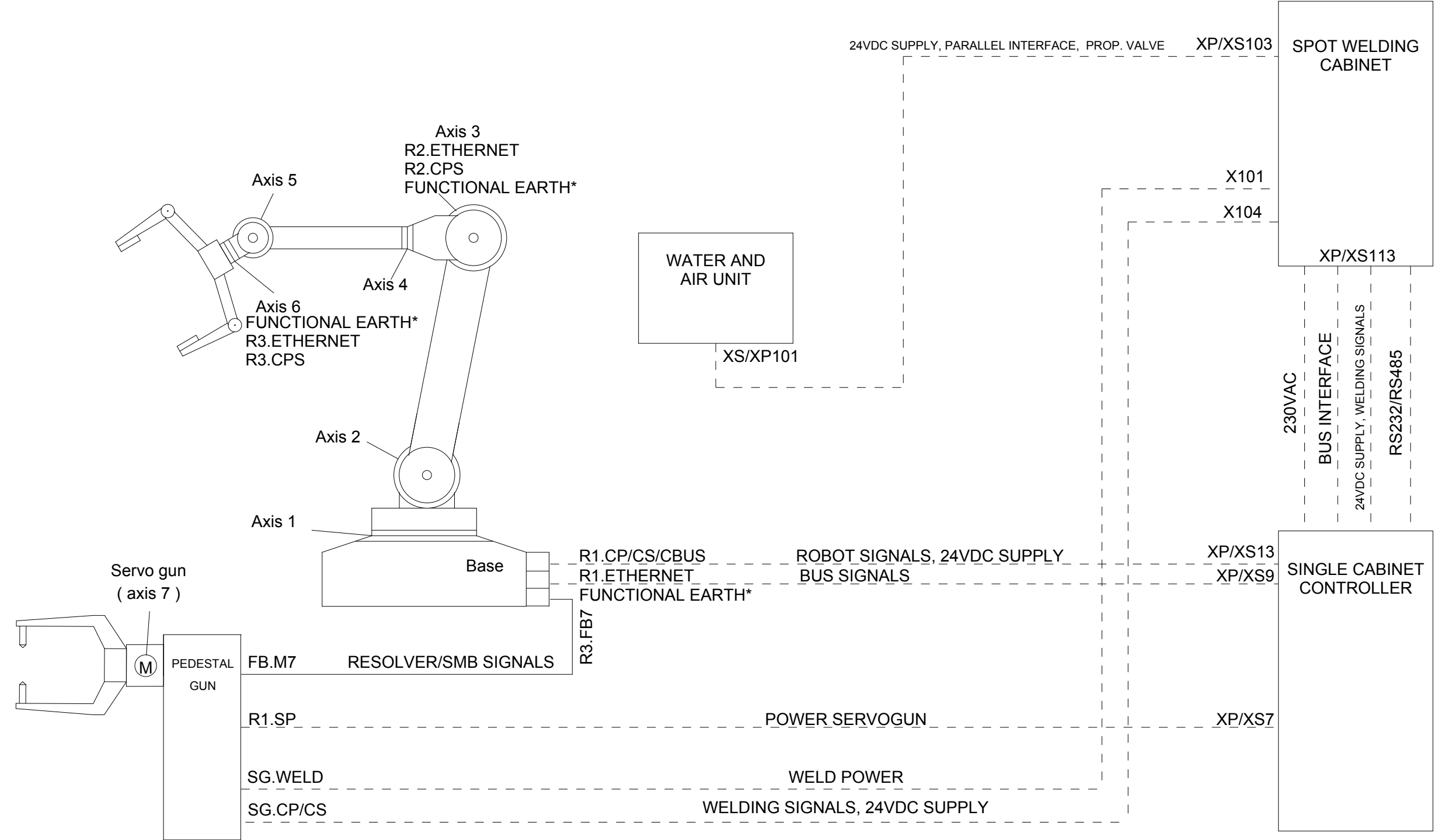

We reserve all rights in this document and in the information contained therein. Reproduction, use or disclosure to third parties without express authority is strictly forbidden. © Copyright 2003 ABB

Latest revision: ECO 105331, WI 241451
 Pg 50-55: Functional earth added.
 Pg 104-105; 155-157; 204-205: New harnesses added,
 including functional earth.



Lab/Office:
 RARO SE
 RDM2

IRB6650S, IRB7600 LeanID
 BLOCK DIAGRAM - TYPE HSe
 DRESS PACK

Status: 2019-08-14
 Approved

Plant: = SP
 Location: + HSe
 Sublocation: +

Document no.
 3HAC022327-002

Rev. Ind
 01
 Page 54
 +CON/55
 Total 31

Prepared by, date: EM 2019-06-26 | Approved by, date: ML 2019-08-14

BLOCK DIAGRAM TYPE S/H

Male (R1.CP/CS)

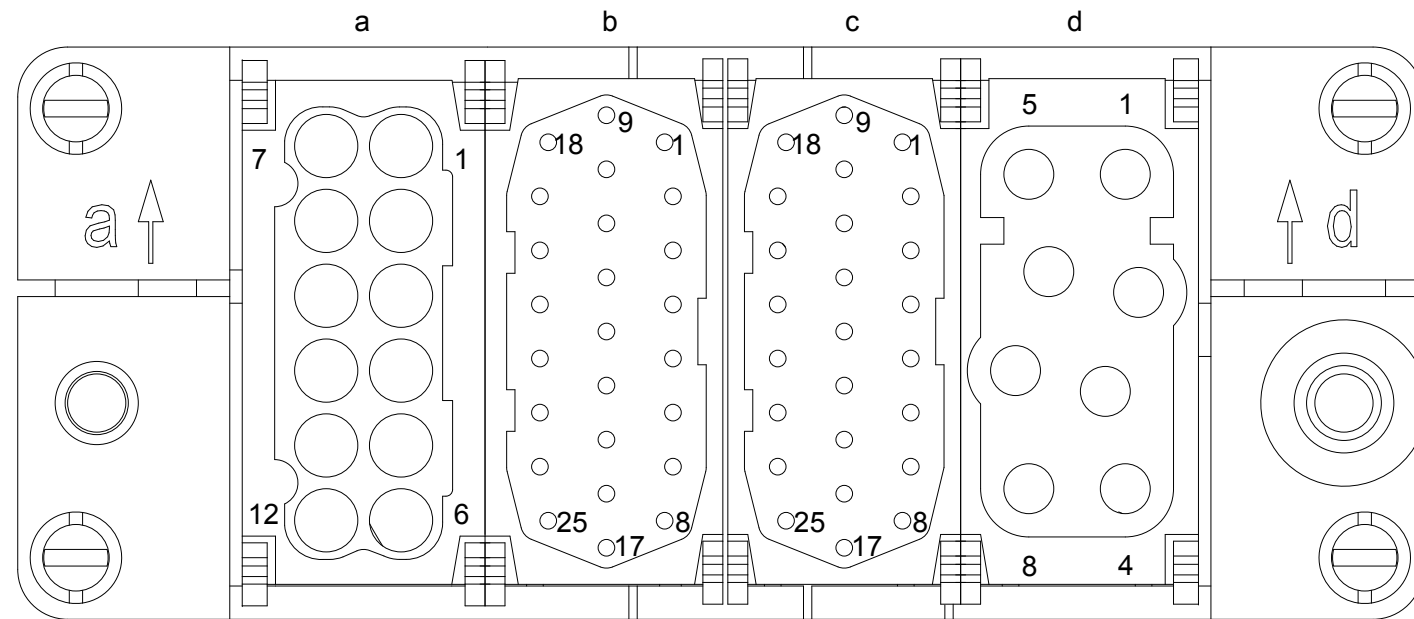

HARTING HAN MODULE/

DD

HD

HD

EE

Male 4p
R2.ETHERNET
R3.ETHERNET

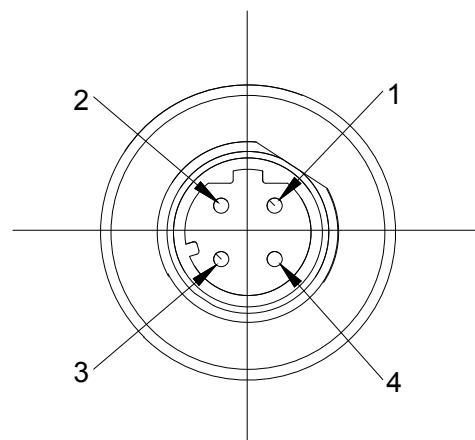

Female 4p
R1.ETHERNET
R2.ETHERNET

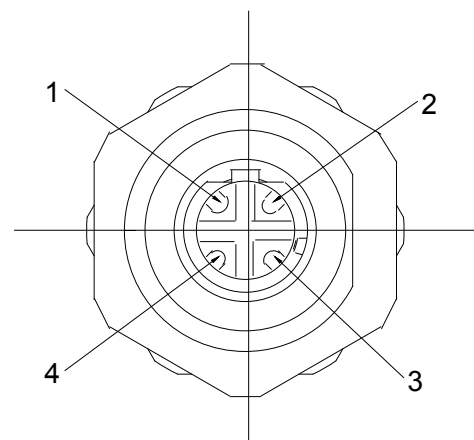

Female 26p (R2.CP/CS)

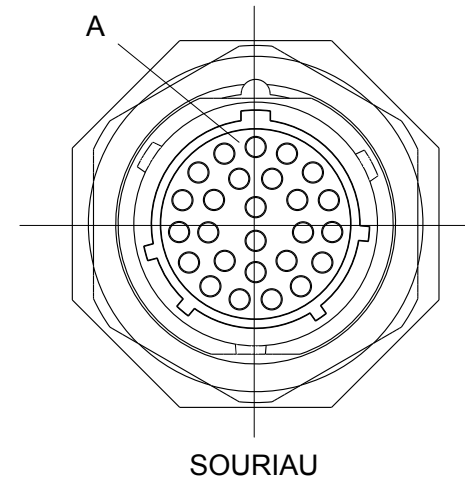

SOURIAU

Female 26p (R3.CPS)
Male 26p (R2.CPS)

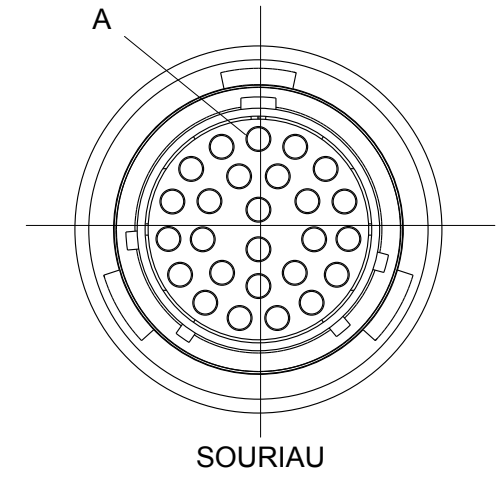

SOURIAU

Female 10p (R2.CBUS)

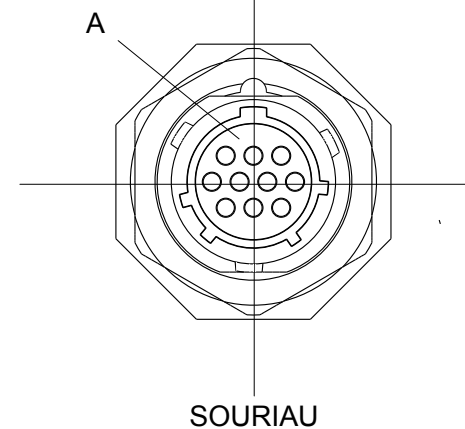

SOURIAU

Male 10p (R2.CBUS)
Female 10p (R3.CBUS)

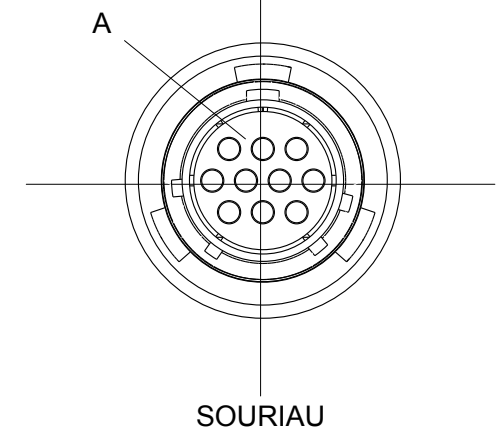

SOURIAU

FUNCTIONAL EARTH

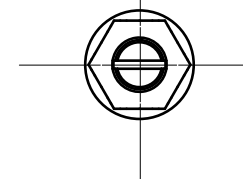

Latest revision: ECO 105331, WI 241451
Pg 50-55: Functional earth added.
Pg 104-105; 155-157; 204-205: New harnesses added,
including functional earth.

Prepared by, date: EM 2019-06-26 | Approved by, date: ML 2019-08-14



Lab/Office:
RARO SE
RDM2

IRB6650S, IRB7600 LeanID

CONNECTOR LAYOUT

DRESS PACK

Status: 2019-08-14

Approved

Document no.

3HAC022327-002

Plant: = SP
Location: + CON
Sublocation: +

Rev. Ind

01

Page 55

56

Total 31

We reserve all rights in this document and in the information contained therein. Reproduction, use or disclosure to third parties without express authority is strictly forbidden. © Copyright 2003 ABB

BLOCK DIAGRAM TYPE Se

Female 23p (R1.SP)

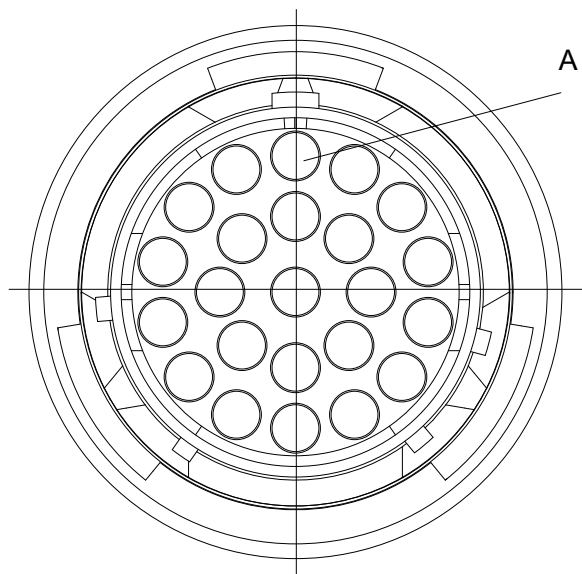

SOURIAU

Male 8p
R2.SP

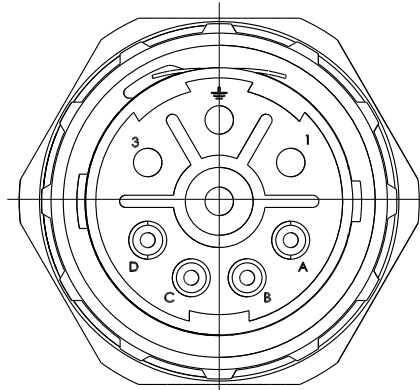

HUMMEL

Female 8p
R2.SP
R3.SP

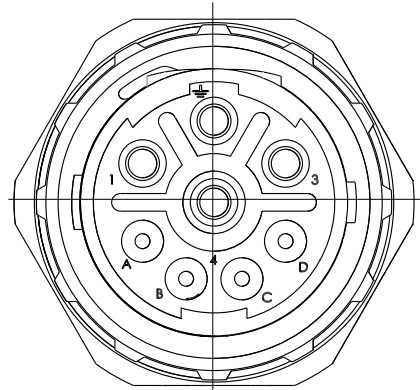

HUMMEL

Female 8p (R2.FB7)

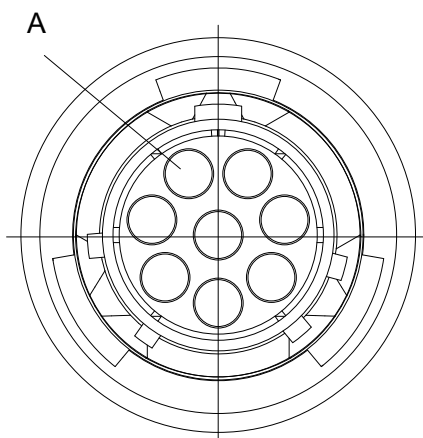

SOURIAU

Male 8p (R2.FB7)

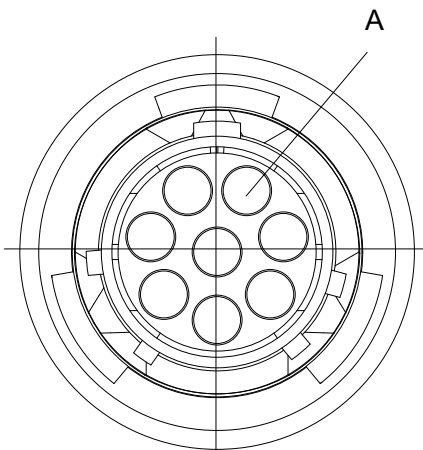

SOURIAU

Male 17p (R3.FB7)

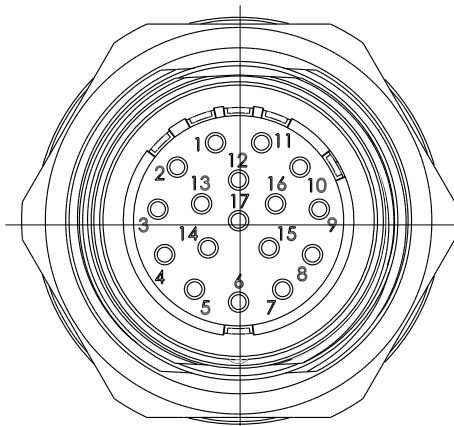

SOURIAU

Female 17p (R3.FB7 & R4.FB7)

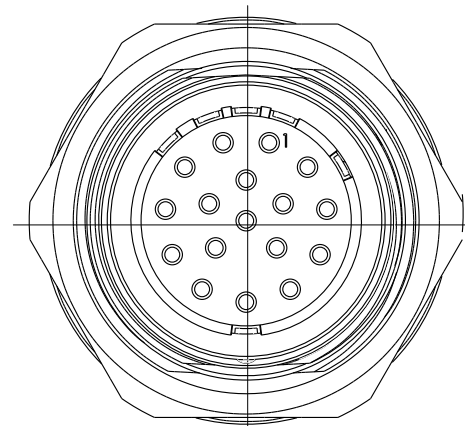

SOURIAU

Latest revision: ECO 105331, WI 241451
Pg 50-55: Functional earth added.
Pg 104-105; 155-157; 204-205: New harnesses added,
including functional earth.

Prepared by, date: EM 2019-06-26 | Approved by, date: ML 2019-08-14



Lab/Office:
RARO SE
RDM2

IRB6650S, IRB7600 LeanID

CONNECTOR LAYOUT

DRESS PACK

Status: 2019-08-14

Approved

Document no.

3HAC022327-002

Plant: = SP
Location: + CON
Sublocation: +

Rev. Ind
01

Page 56
=DP+S
Total 31

We reserve all rights in this document and in the information contained therein. Reproduction, use or disclosure to third parties without express authority is strictly forbidden. © Copyright 2003 ABB

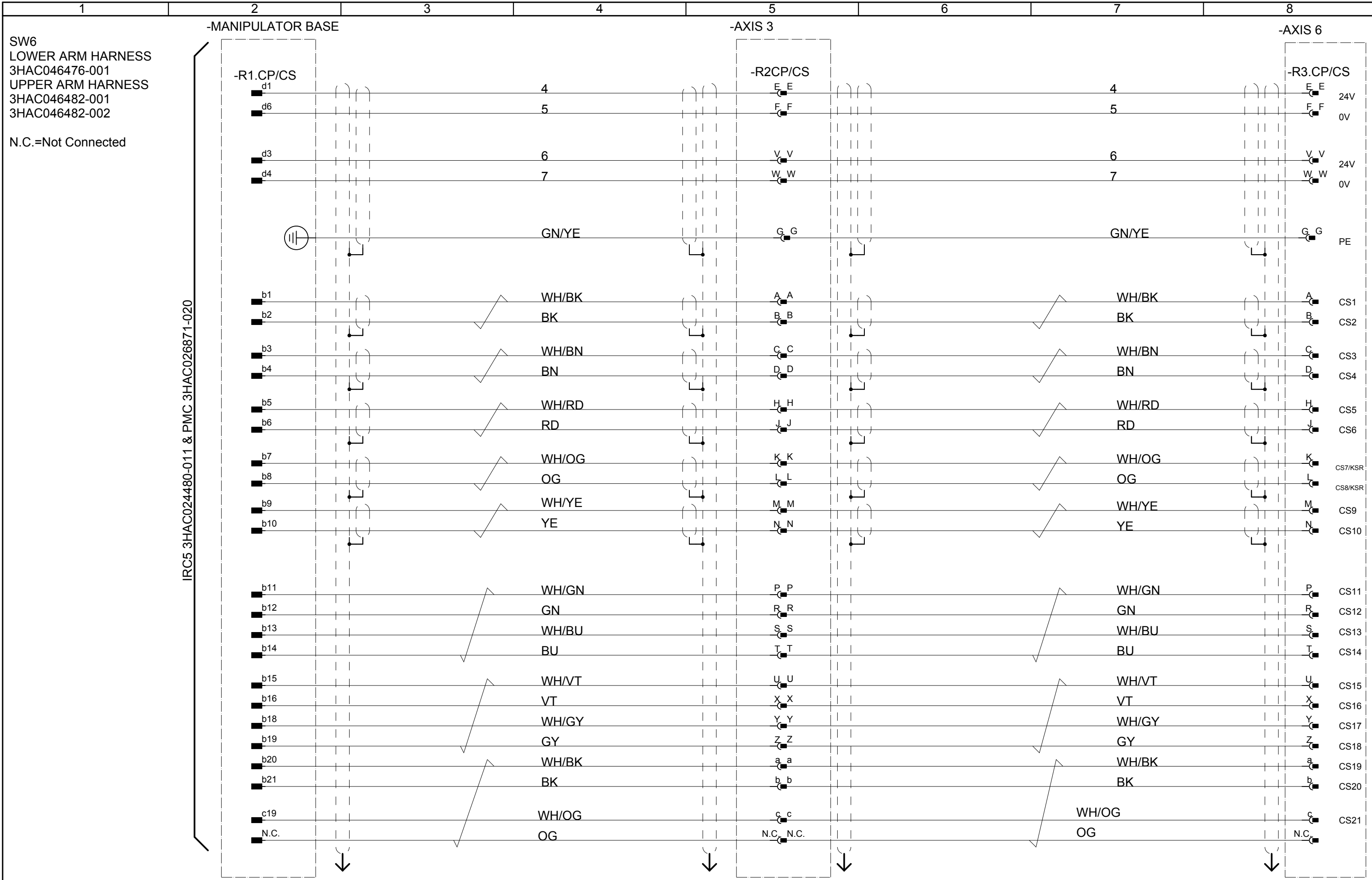

IRC5 3HAC024480-011 & PMC 3HAC026871-020

We reserve all rights in this document and in the information contained therein. Reproduction, use or disclosure to third parties without express authority is strictly forbidden. © Copyright 2003 ABB

Latest revision: ECO 105331, WI 241451
 Pg 50-55: Functional earth added.
 Pg 104-105; 155-157; 204-205: New harnesses added, including functional earth.

Prepared by, date: EM 2019-06-26 Approved by, date: ML 2019-08-14

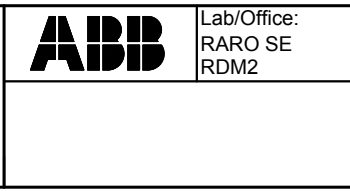

IRB6650S, IRB7600 LeanID

PARACOM SW6

TYPE S

Status: 2019-08-14

Plant: = DP
 Location: + S
 Sublocation: + AX3

Approved

Document no. 3HAC022327-002

Rev. Ind 01

Page 100
 101
 Total 31

We reserve all rights in this document and in the information contained therein. Reproduction, use or disclosure to third parties without express authority is strictly forbidden. © Copyright 2003 ABB

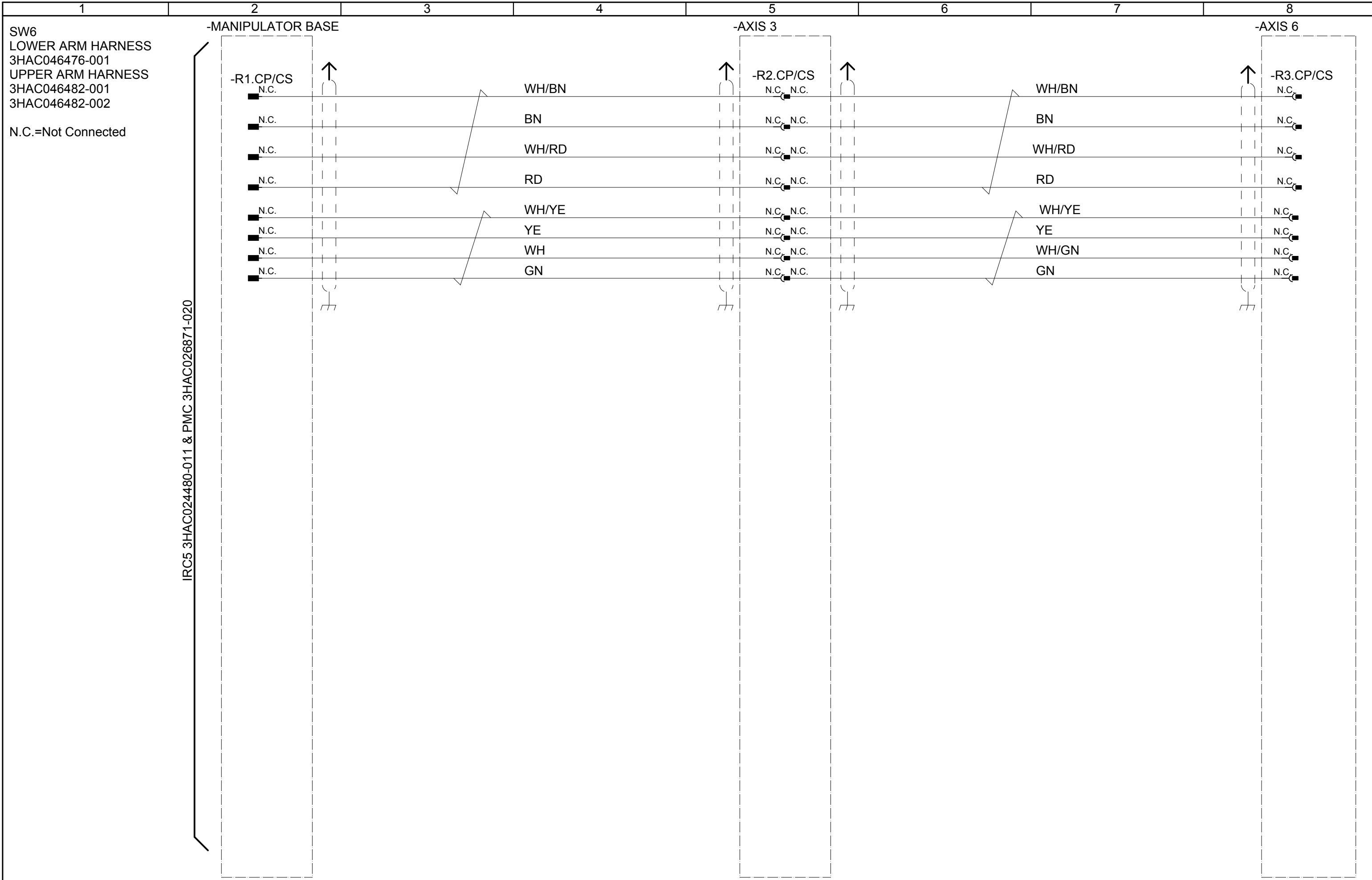

Latest revision: ECO 105331, WI 241451
 Pg 50-55: Functional earth added.
 Pg 104-105; 155-157; 204-205: New harnesses added,
 including functional earth.

Prepared by, date: EM 2019-06-26 | Approved by, date: ML 2019-08-14

ABB Lab/Office:
 RARO SE
 RDM2

IRB6650S, IRB7600 LeanID
 PARACOM SW6
 TYPE S

Status: 2019-08-14	Plant: = DP
Approved	Location: + S
Document no. 3HAC022327-002	Sublocation: + AX3
Rev. Ind 01	Page 101
	102
	Total 31

We reserve all rights in this document and in the information contained therein. Reproduction, use or disclosure to third parties without express authority is strictly forbidden. © Copyright 2003 ABB

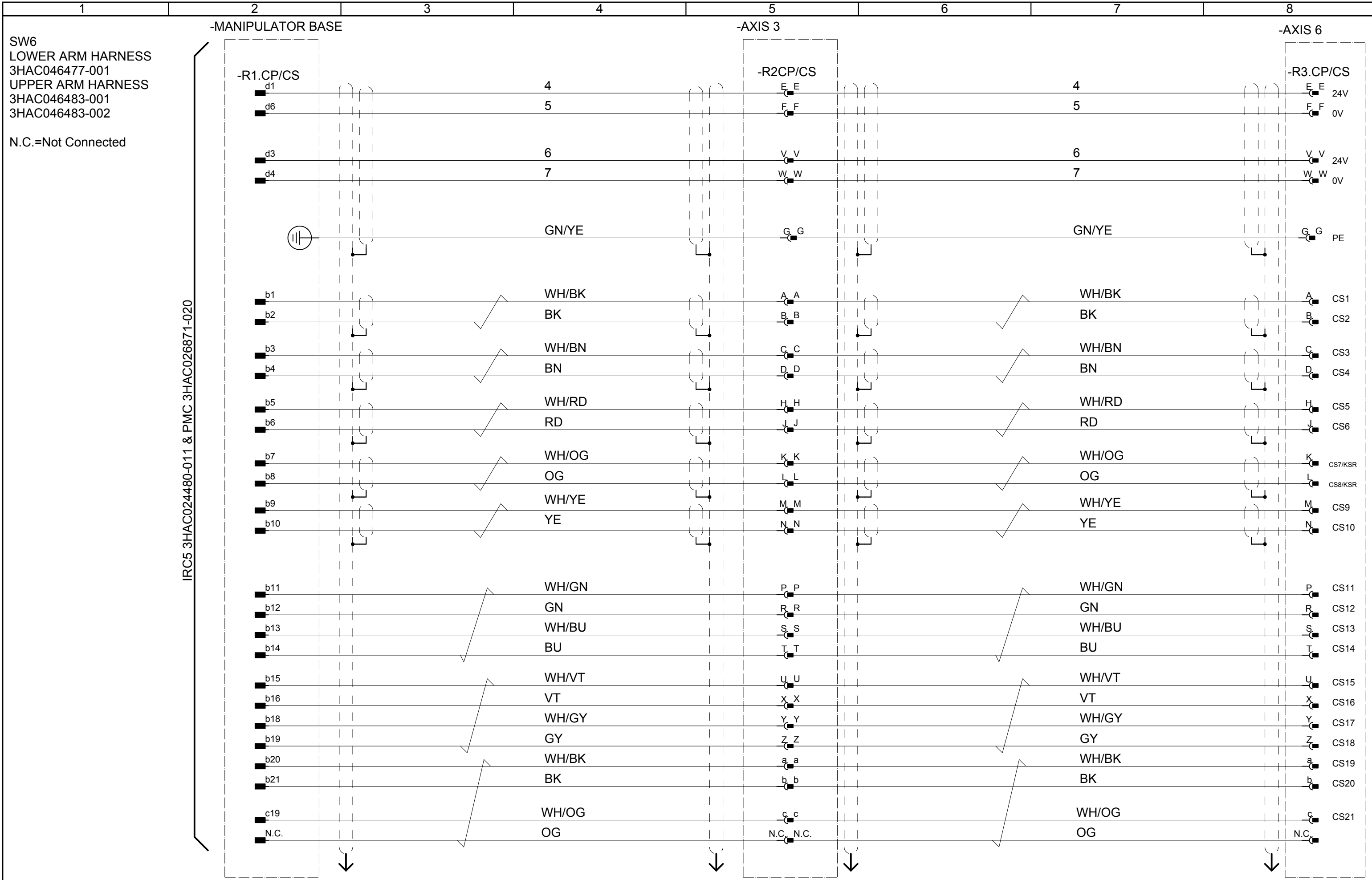

IRC5 3HAC024480-011 & PMC 3HAC026871-020

Latest revision: ECO 105331, WI 241451
 Pg 50-55: Functional earth added.
 Pg 104-105; 155-157; 204-205: New harnesses added, including functional earth.

Prepared by, date: EM 2019-06-26 | Approved by, date: ML 2019-08-14

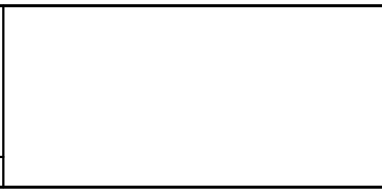

Lab/Office: RARO SE RDM2

IRB6650S, IRB7600 LeanID

PARABUSCOM SW6

TYPE S

Status: 2019-08-14

Plant: = DP
 Location: + S
 Sublocation: + AX3

Approved

Document no. 3HAC022327-002

Rev. Ind 01

Page 102
 103
 Total 31

We reserve all rights in this document and in the information contained therein. Reproduction, use or disclosure to third parties without express authority is strictly forbidden. © Copyright 2003 ABB

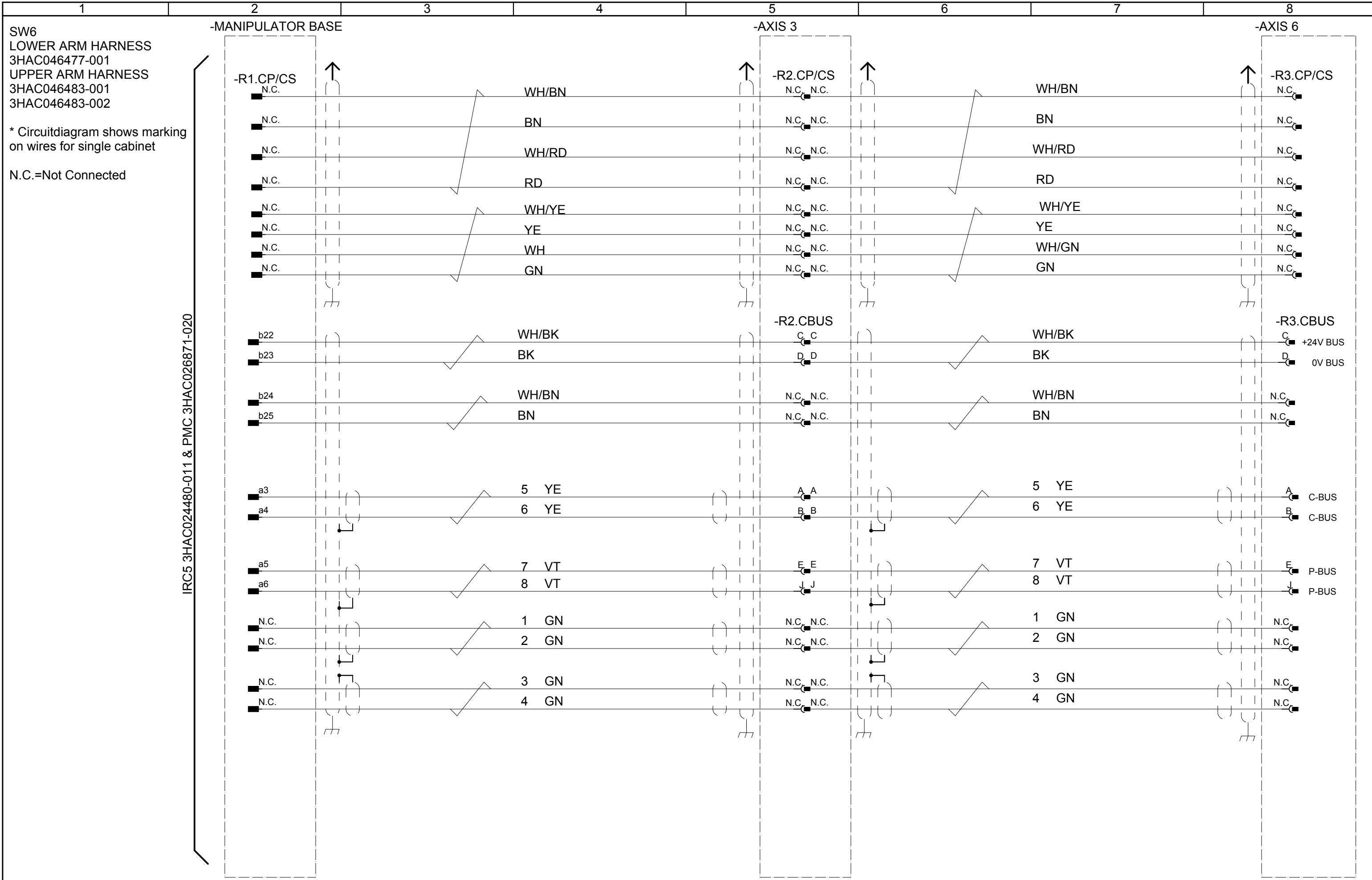

SW6
 LOWER ARM HARNESS
 3HAC046477-001
 UPPER ARM HARNESS
 3HAC046483-001
 3HAC046483-002

* Circuitdiagram shows marking on wires for single cabinet

N.C.=Not Connected

IRC5 3HAC024480-011 & PMC 3HAC026871-020

Latest revision: ECO 105331, WI 241451
 Pg 50-55: Functional earth added.
 Pg 104-105; 155-157; 204-205: New harnesses added, including functional earth.

Prepared by, date: EM 2019-06-26 | Approved by, date: ML 2019-08-14

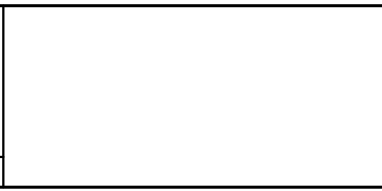

Lab/Office:
 RARO SE
 RDM2

IRB6650S, IRB7600 LeanID

PARABUSCOM SW6

TYPE S

Status: 2019-08-14

Plant: = DP
 Location: + S
 Sublocation: + AX3

Approved

Document no. 3HAC022327-002

Rev. Ind 01

Page 103
 104
 Total 31

We reserve all rights in this document and in the information contained therein. Reproduction, use or disclosure to third parties without express authority is strictly forbidden. © Copyright 2003 ABB

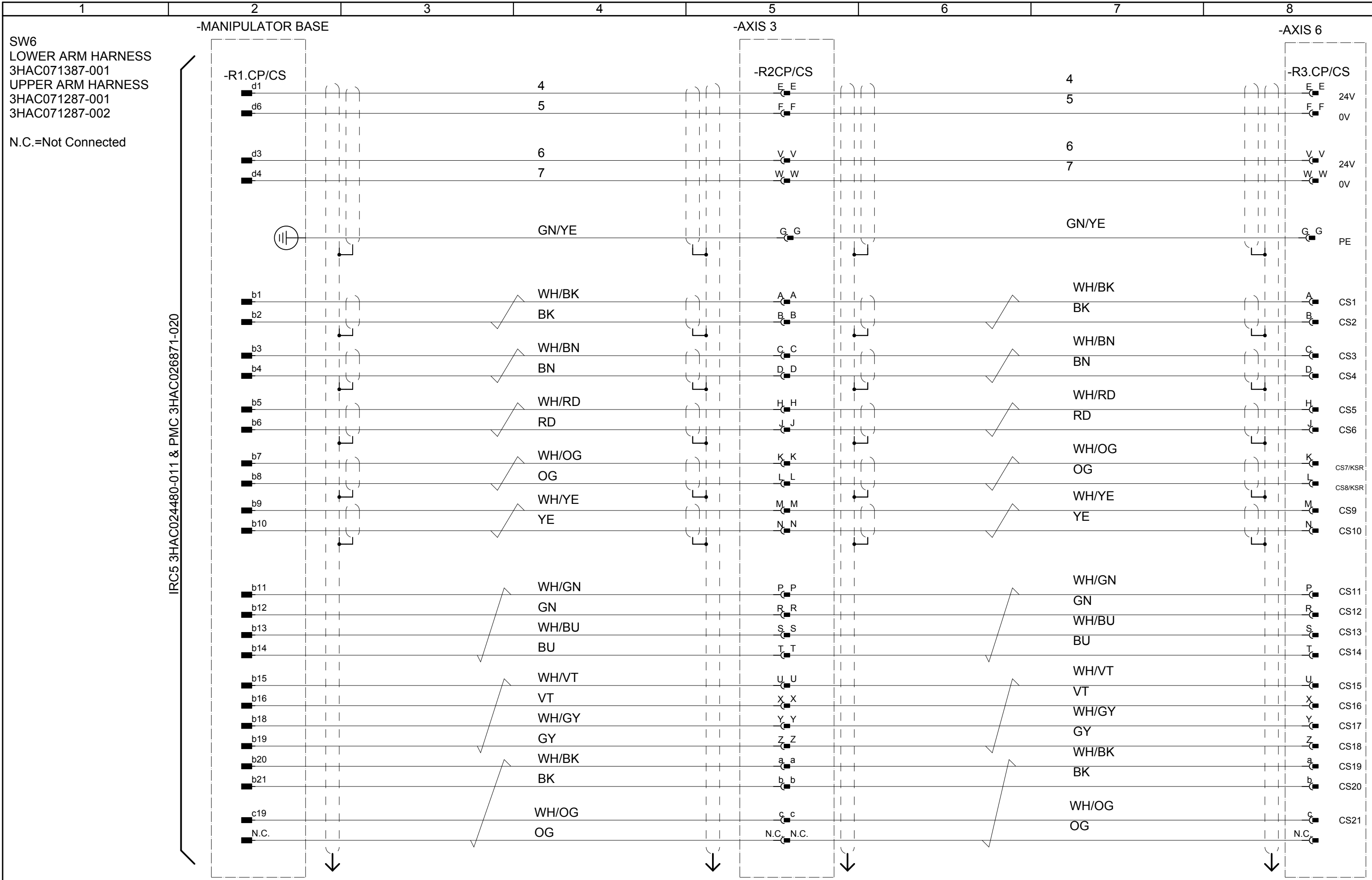

Latest revision: ECO 105331, WI 241451
 Pg 50-55: Functional earth added.
 Pg 104-105; 155-157; 204-205: New harnesses added, including functional earth.

Prepared by, date: EM 2019-06-26 | Approved by, date: ML 2019-08-14

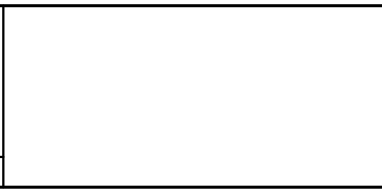

Lab/Office: RARO SE RDM2

IRB6650S, IRB7600 LeanID

PARAMULTI SW6

TYPE S

Status: 2019-08-14

Plant: = DP
 Location: + S
 Sublocation: + AX3

Approved

Document no. 3HAC022327-002

Rev. Ind 01

Page 104
 105
 Total 31

We reserve all rights in this document and in the information contained therein. Reproduction, use or disclosure to third parties without express authority is strictly forbidden. © Copyright 2003 ABB

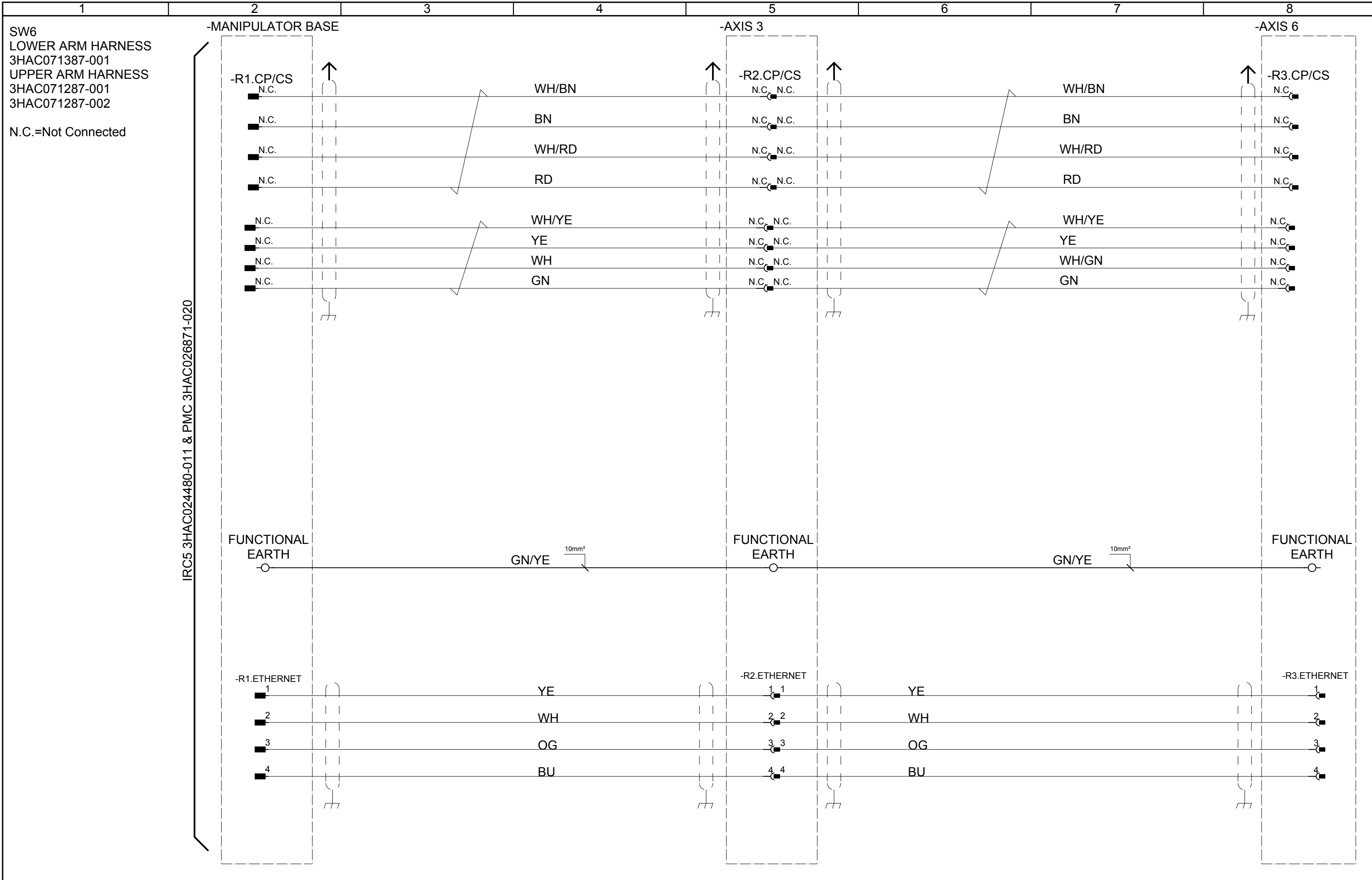

Latest revision: ECO 105331, WI 241451
 Pg 50-55: Functional earth added.
 Pg 104-105; 155-157; 204-205: New harnesses added, including functional earth.

Prepared by, date: EM 2019-06-26 Approved by, date: ML 2019-08-14

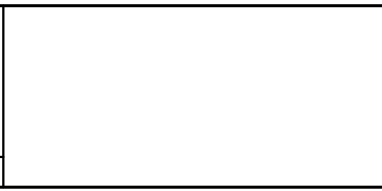

Lab/Office: RARO SE RDM2

IRB6650S, IRB7600 LeanID

PARAMULTI SW6

TYPE S

Status: 2019-08-14

Plant: = DP
 Location: + S
 Sublocation: + AX3

Approved

Document no. 3HAC022327-002

Rev. Ind 01

Page 105
 +Se.AX3
 Total 31

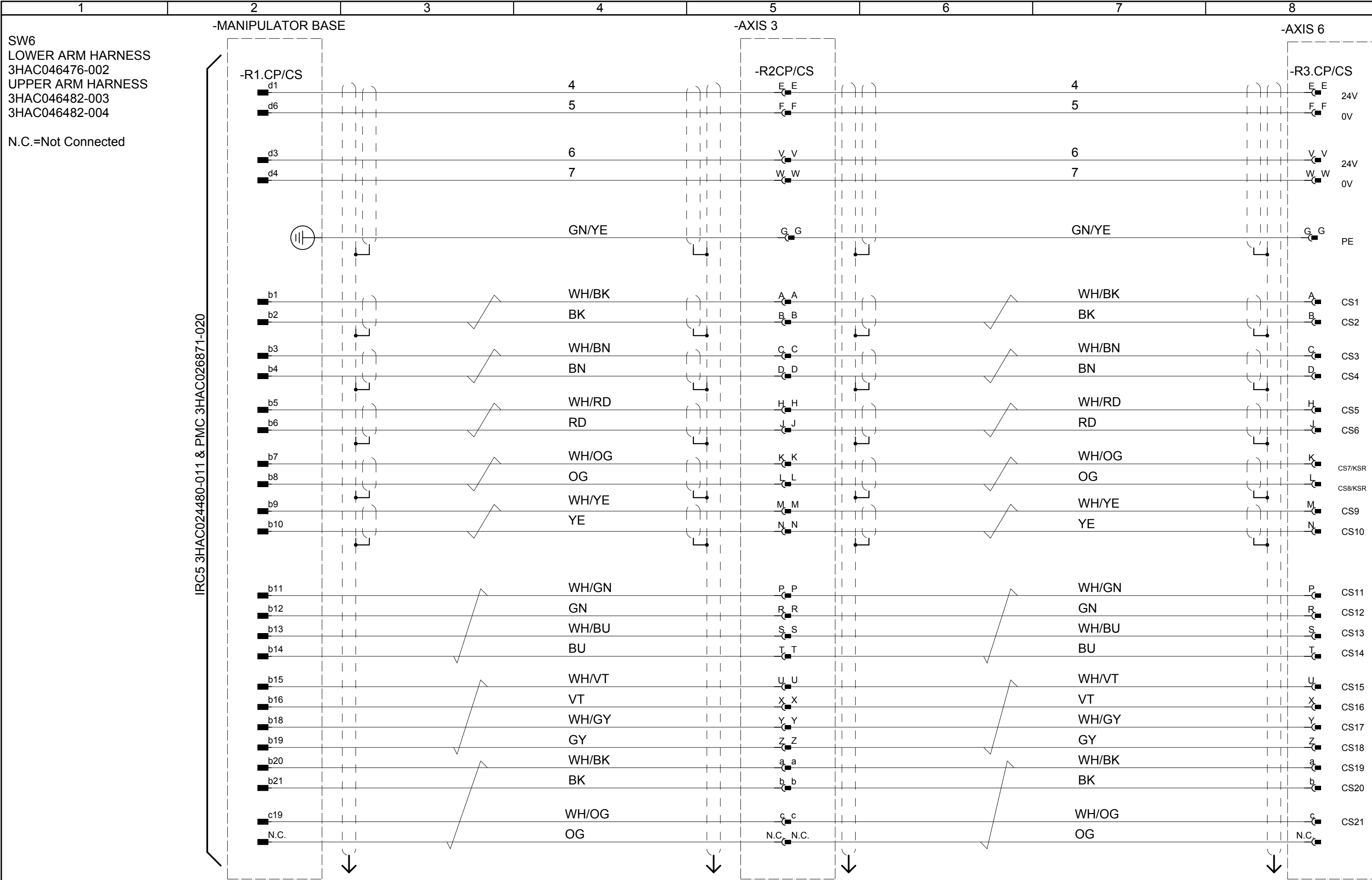

We reserve all rights in this document and in the information contained therein. Reproduction, use or disclosure to third parties without express authority is strictly forbidden. © Copyright 2003 ABB

Latest revision: ECO 105331, WI 241451
Pg 50-55: Functional earth added.
Pg 104-105; 155-157; 204-205: New harnesses added,
including functional earth.

Prepared by, date: EM 2019-06-26 | Approved by, date: ML 2019-08-14

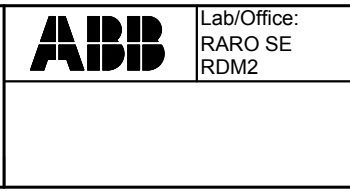

IRB6650S, IRB7600 LeanID
PARACOM, SERVOGUN SW6
TYPE Se

Status: 2019-08-14
Approved
Document no. 3HAC022327-002
Rev. Ind 01
Page 150
151
Total 31

Plant: = DP
Location: + Se
Sublocation: + AX3

We reserve all rights in this document and in the information contained therein. Reproduction, use or disclosure to third parties without express authority is strictly forbidden. © Copyright 2003 ABB

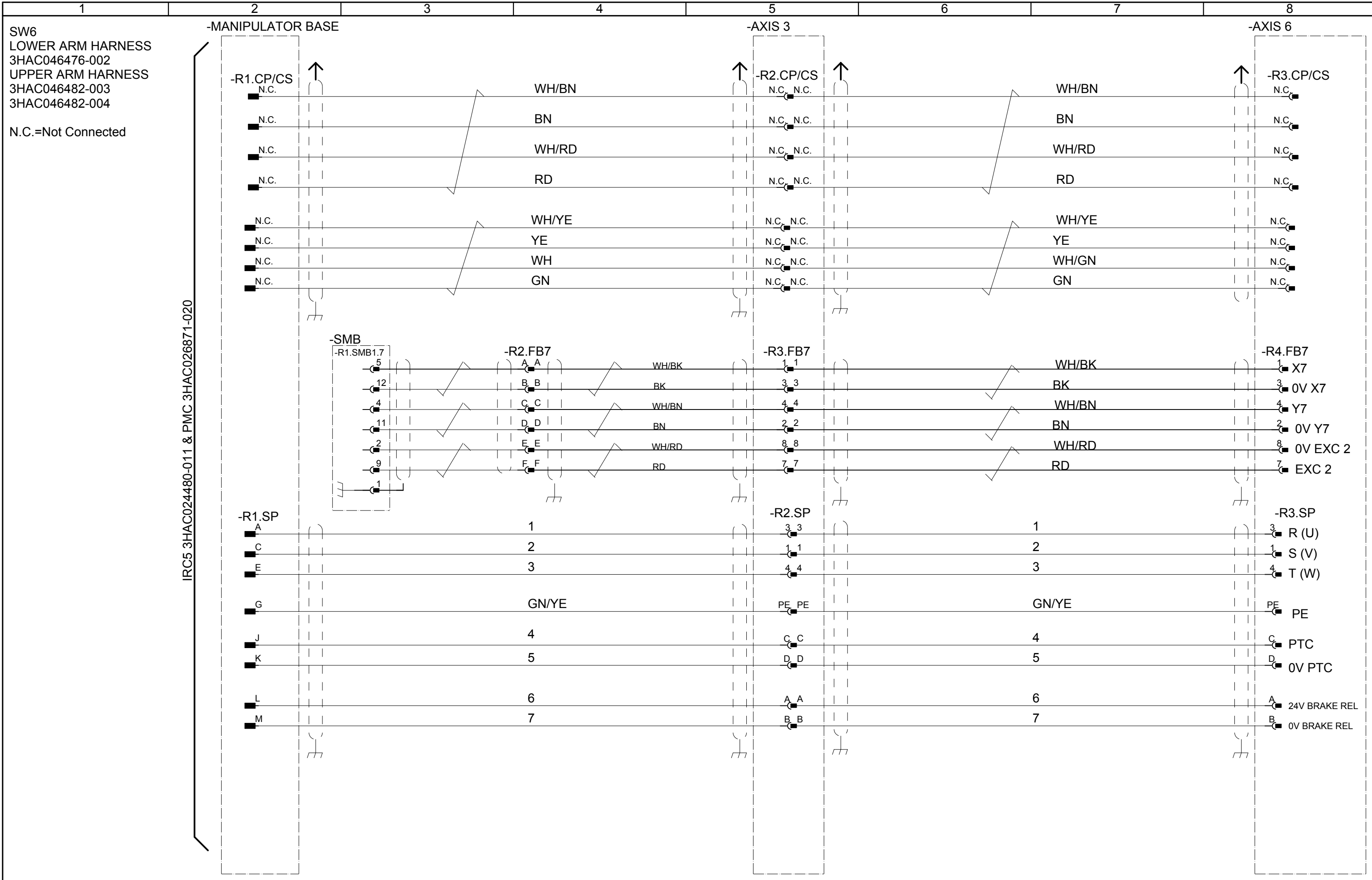

Latest revision: ECO 105331, WI 241451
 Pg 50-55: Functional earth added.
 Pg 104-105; 155-157; 204-205: New harnesses added,
 including functional earth.

Prepared by, date: EM 2019-06-26 | Approved by, date: ML 2019-08-14

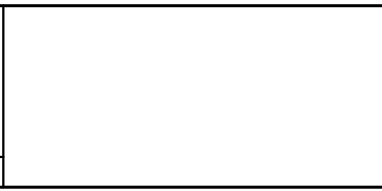

Lab/Office:
 RARO SE
 RDM2

IRB6650S, IRB7600 LeanID
 PARACOM, SERVOGUN SW6
 TYPE Se

Status: 2019-08-14
 Approved
 Document no. 3HAC022327-002
 Plant: = DP
 Location: + Se
 Sublocation: + AX3
 Rev. Ind 01
 Page 151
 152
 Total 31

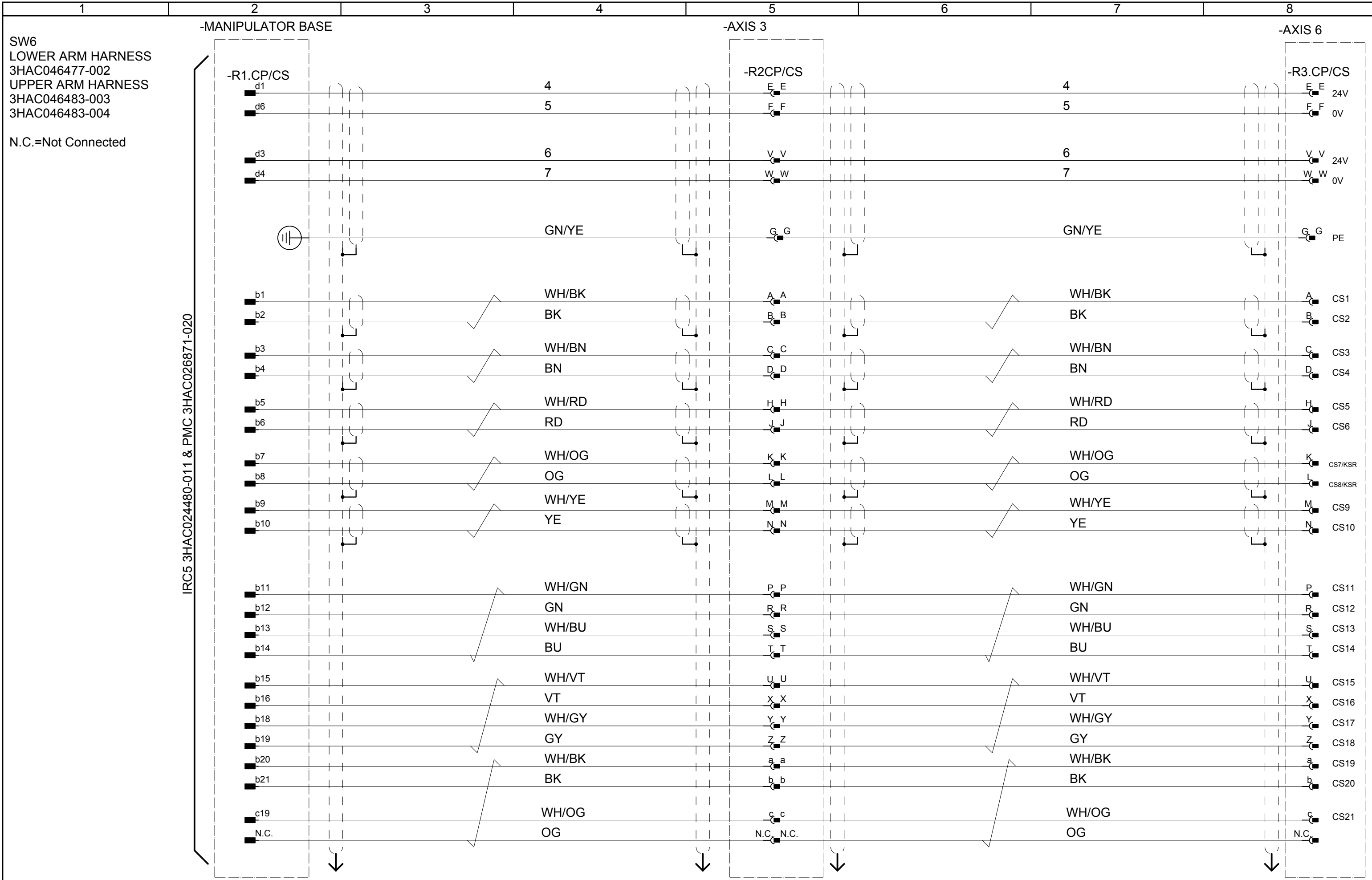

SW6
 LOWER ARM HARNESS
 3HAC046477-002
 UPPER ARM HARNESS
 3HAC046483-003
 3HAC046483-004
 N.C.=Not Connected

IRC5 3HAC024480-011 & PMC 3HAC026871-020

We reserve all rights in this document and in the information contained therein. Reproduction, use or disclosure to third parties without express authority is strictly forbidden. © Copyright 2003 ABB

Latest revision: ECO 105331, WI 241451
 Pg 50-55: Functional earth added.
 Pg 104-105; 155-157; 204-205: New harnesses added,
 including functional earth.

Prepared by, date: EM 2019-06-26 Approved by, date: ML 2019-08-14



Lab/Office:
 RARO SE
 RDM2

IRB6650S, IRB7600 LeanID
 PARABUSCOM, SERVOGUN SW6
 TYPE Se

Status: 2019-08-14
 Approved
 Document no. 3HAC022327-002

Plant: = DP
 Location: + Se
 Sublocation: + AX3

Rev. Ind 01
 Page 152
 153
 Total 31

We reserve all rights in this document and in the information contained therein. Reproduction, use or disclosure to third parties without express authority is strictly forbidden. © Copyright 2003 ABB

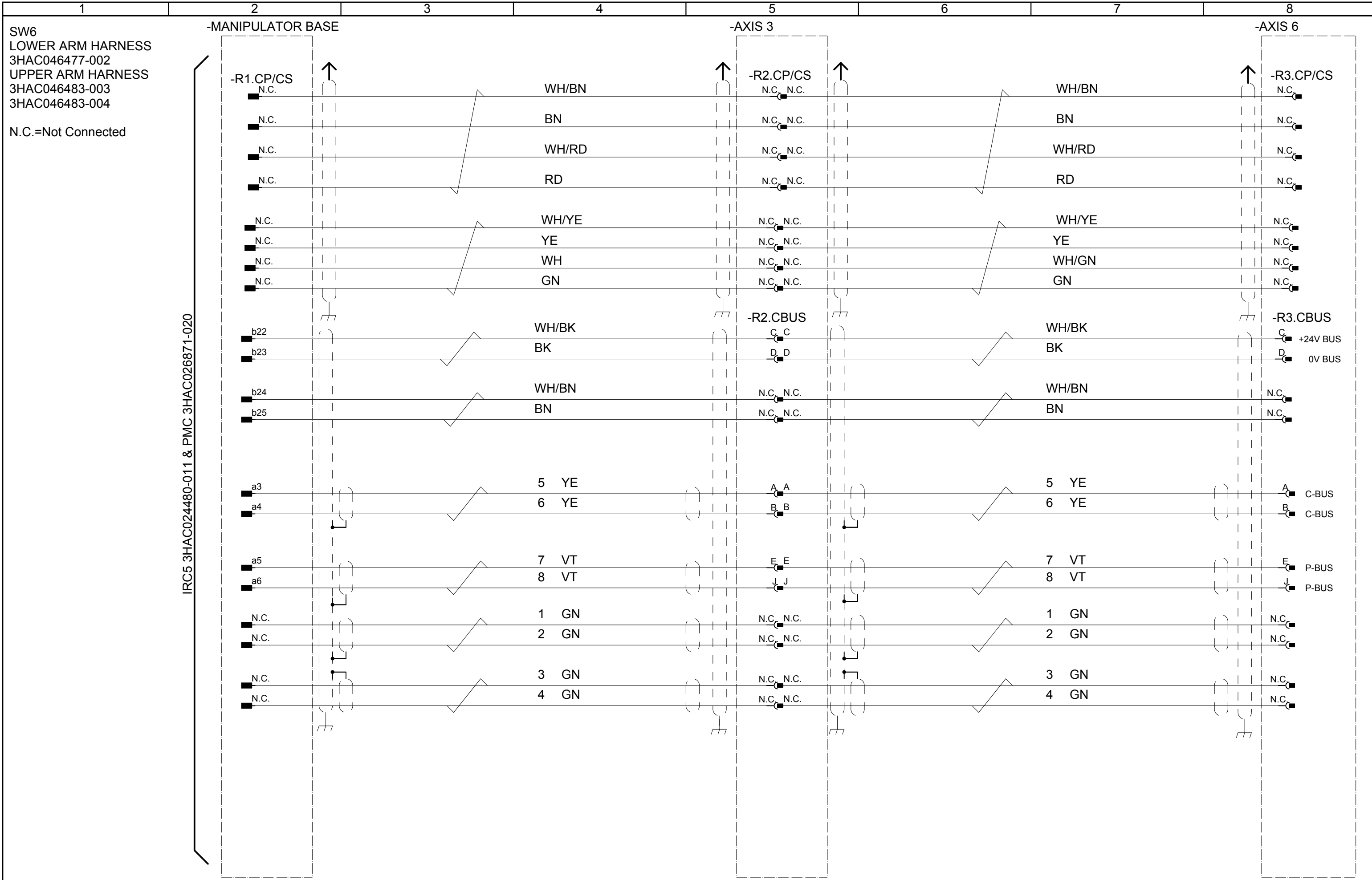

Latest revision: ECO 105331, WI 241451
Pg 50-55: Functional earth added.
Pg 104-105; 155-157; 204-205: New harnesses added,
including functional earth.

Prepared by, date: EM 2019-06-26 | Approved by, date: ML 2019-08-14

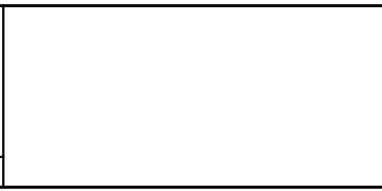

Lab/Office:
RARO SE
RDM2

IRB6650S, IRB7600 LeanID

PARABUSCOM, SERVOGUN SW6

TYPE Se

Status: 2019-08-14

Plant: = DP
Location: + Se
Sublocation: + AX3

Approved

Document no. 3HAC022327-002

Rev. Ind 01

Page 153
154
Total 31

We reserve all rights in this document and in the information contained therein. Reproduction, use or disclosure to third parties without express authority is strictly forbidden. © Copyright 2003 ABB

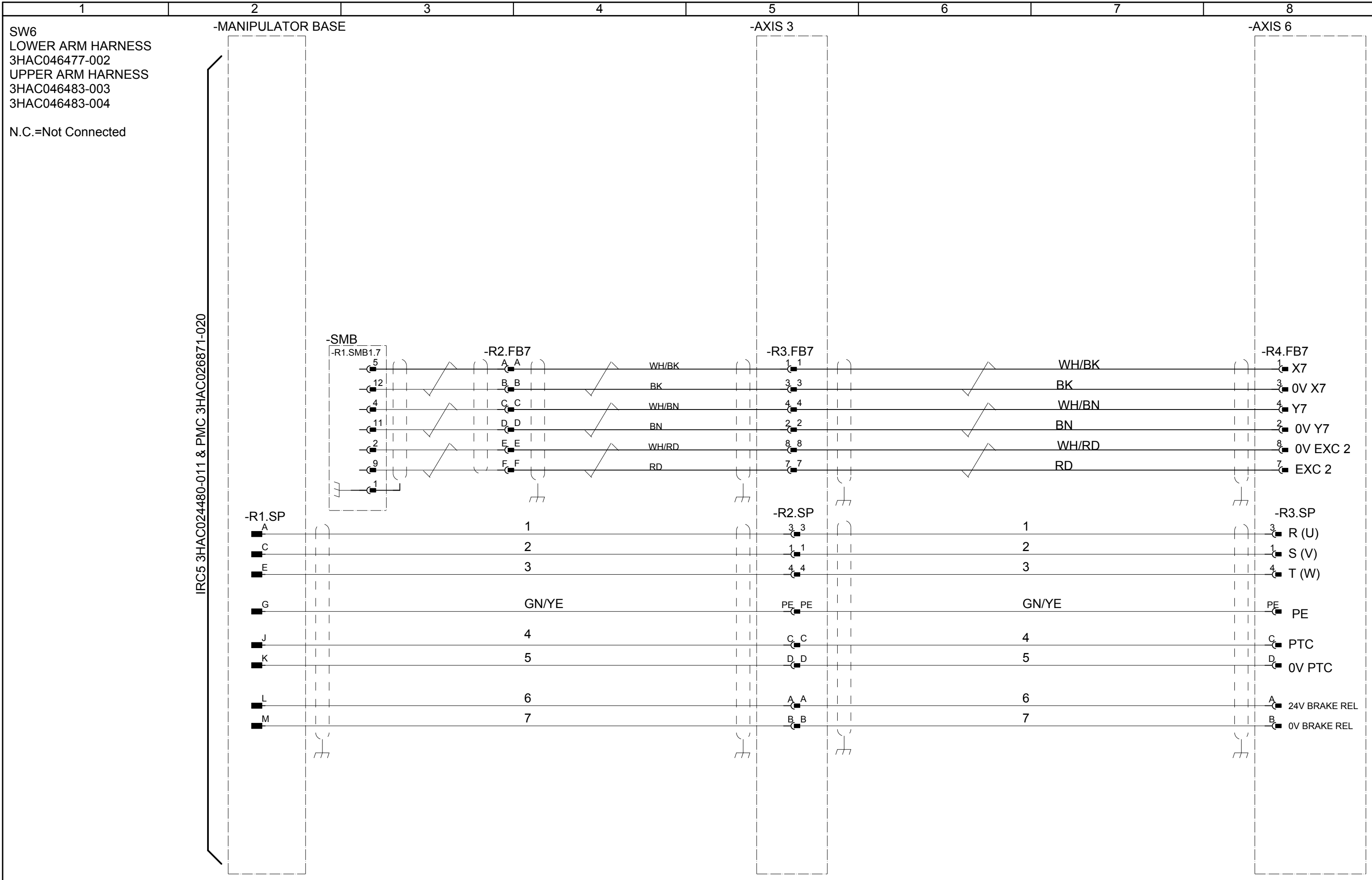

Latest revision: ECO 105331, WI 241451
 Pg 50-55: Functional earth added.
 Pg 104-105; 155-157; 204-205: New harnesses added,
 including functional earth.

Prepared by, date: EM 2019-06-26 | Approved by, date: ML 2019-08-14



Lab/Office: RARO SE RDM2

IRB6650S, IRB7600 LeanID

PARABUSCOM, SERVOGUN SW6

TYPE Se

Status: 2019-08-14

Plant: = DP
 Location: + Se
 Sublocation: + AX3

Approved

Document no. 3HAC022327-002

Rev. Ind 01

Page 154
 155
 Total 31

We reserve all rights in this document and in the information contained therein. Reproduction, use or disclosure to third parties without express authority is strictly forbidden. © Copyright 2003 ABB

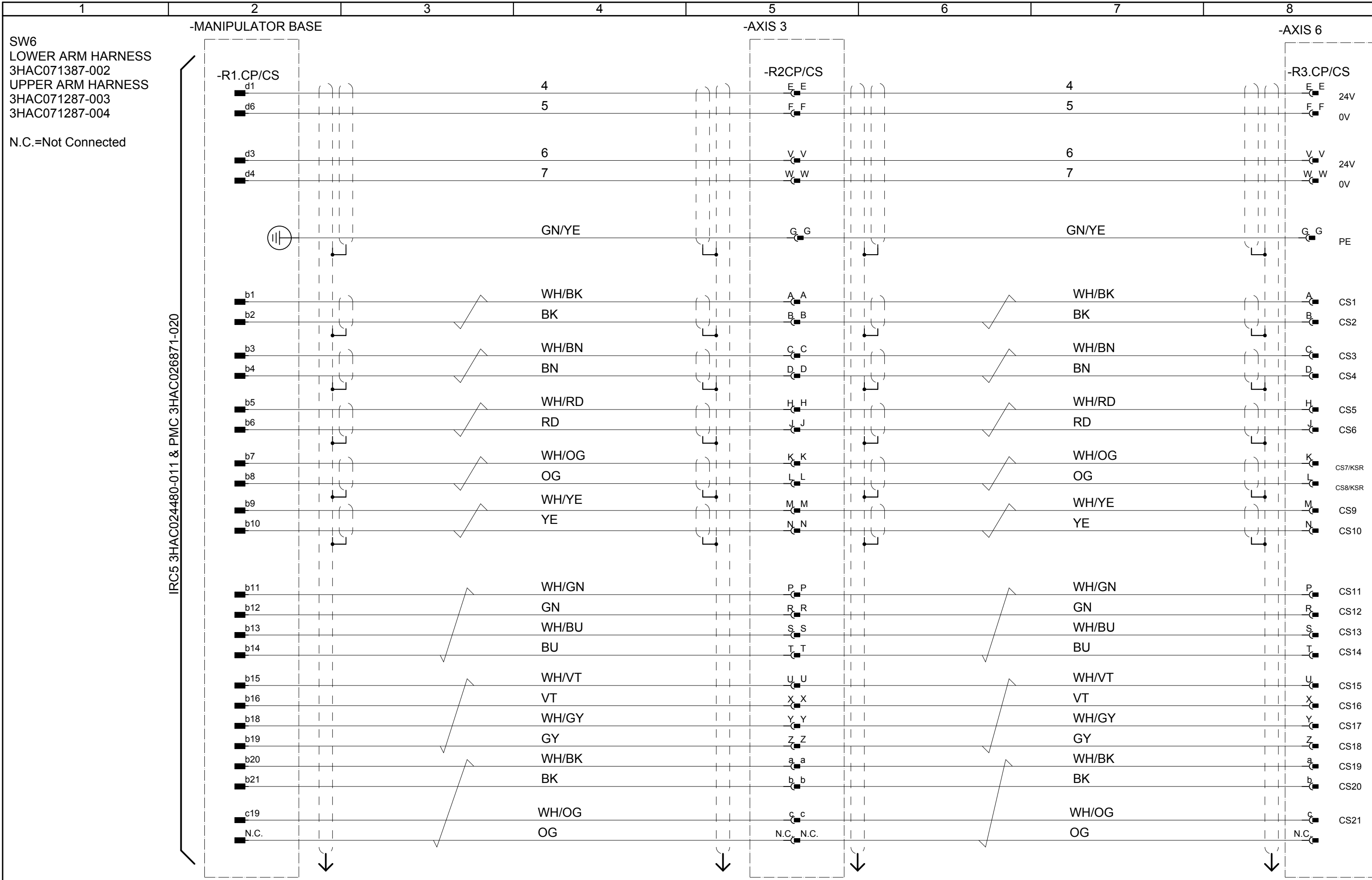

Latest revision: ECO 105331, WI 241451
 Pg 50-55: Functional earth added.
 Pg 104-105; 155-157; 204-205: New harnesses added,
 including functional earth.

Prepared by, date: EM 2019-06-26 | Approved by, date: ML 2019-08-14

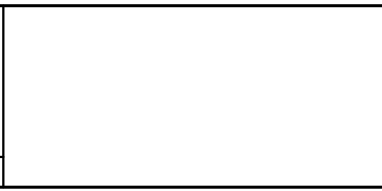

Lab/Office: RARO SE RDM2

IRB6650S, IRB7600 LeanID

PARAMULTI, SERVOGUN SW6

TYPE Se

Status: 2019-08-14

Plant: = DP
 Location: + Se
 Sublocation: + AX3

Approved

Document no. 3HAC022327-002

Rev. Ind 01

Page 155
 156
 Total 31

We reserve all rights in this document and in the information contained therein. Reproduction, use or disclosure to third parties without express authority is strictly forbidden. © Copyright 2003 ABB

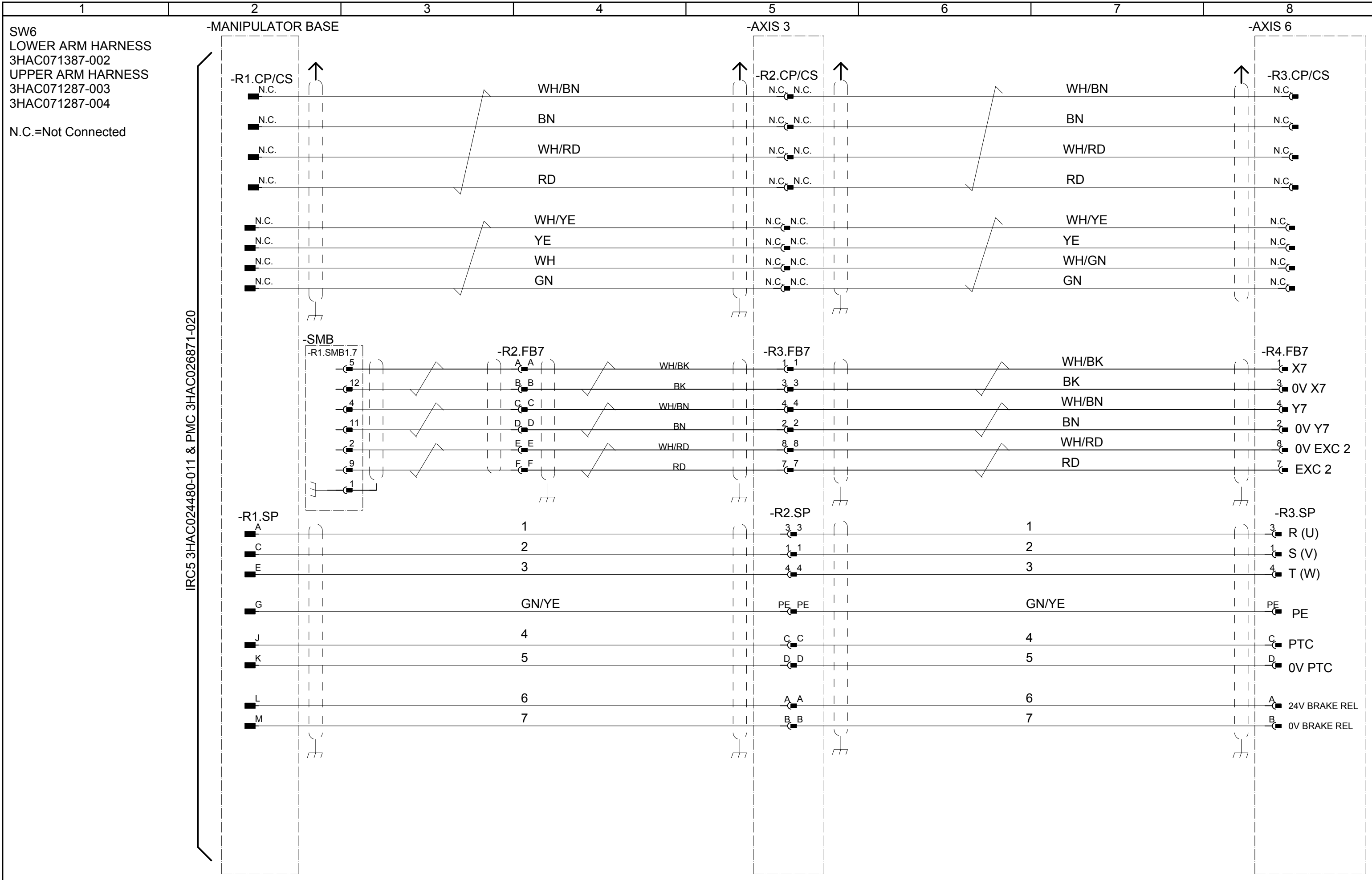

IRC5 3HAC024480-011 & PMC 3HAC026871-020

Latest revision: ECO 105331, WI 241451
 Pg 50-55: Functional earth added.
 Pg 104-105; 155-157; 204-205: New harnesses added,
 including functional earth.

Prepared by, date: EM 2019-06-26 | Approved by, date: ML 2019-08-14

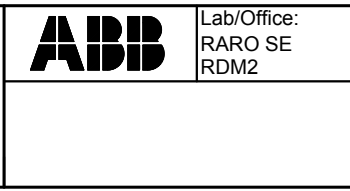

Lab/Office:
 RARO SE
 RDM2

IRB6650S, IRB7600 LeanID
 PARAMULTI, SERVOGUN SW6
 TYPE Se

Status: 2019-08-14
 Approved
 Document no. 3HAC022327-002

Plant: = DP
 Location: + Se
 Sublocation: + AX3

Rev. Ind Page 156
 01 157
 Total 31

We reserve all rights in this document and in the information contained therein. Reproduction, use or disclosure to third parties without express authority is strictly forbidden. © Copyright 2003 ABB

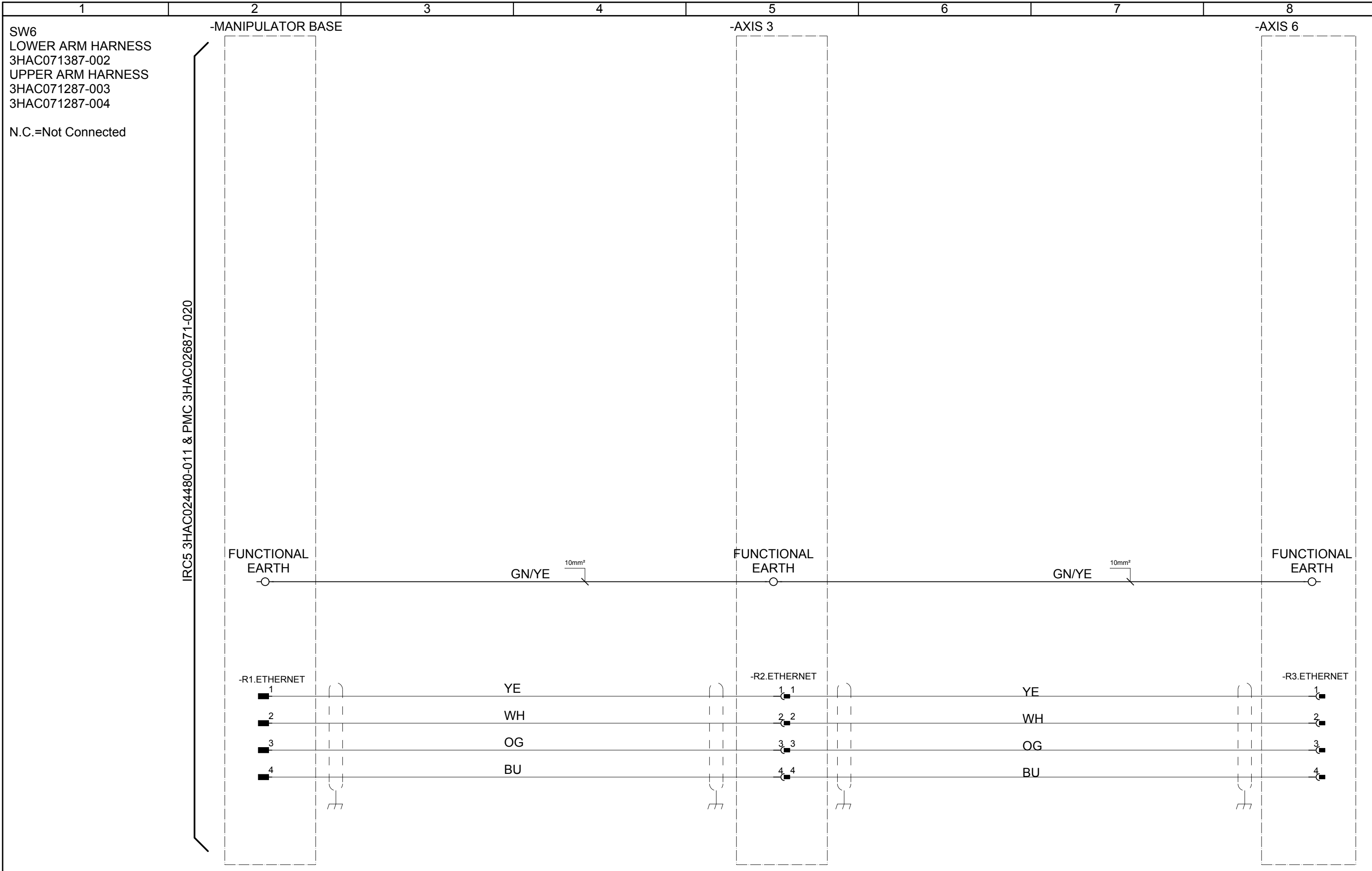

Latest revision: ECO 105331, WI 241451
 Pg 50-55: Functional earth added.
 Pg 104-105; 155-157; 204-205: New harnesses added,
 including functional earth.

Prepared by, date: EM 2019-06-26 Approved by, date: ML 2019-08-14



Lab/Office:
 RARO SE
 RDM2

IRB6650S, IRB7600 LeanID
 PARAMULTI, SERVOGUN SW6
 TYPE Se

Status: 2019-08-14
 Approved
 Document no. 3HAC022327-002

Plant: = DP
 Location: + Se
 Sublocation: + AX3

Rev. Ind 01
 Page 157
 +H.AX3/2
 Total 31

We reserve all rights in this document and in the information contained therein. Reproduction, use or disclosure to third parties without express authority is strictly forbidden. © Copyright 2003 ABB

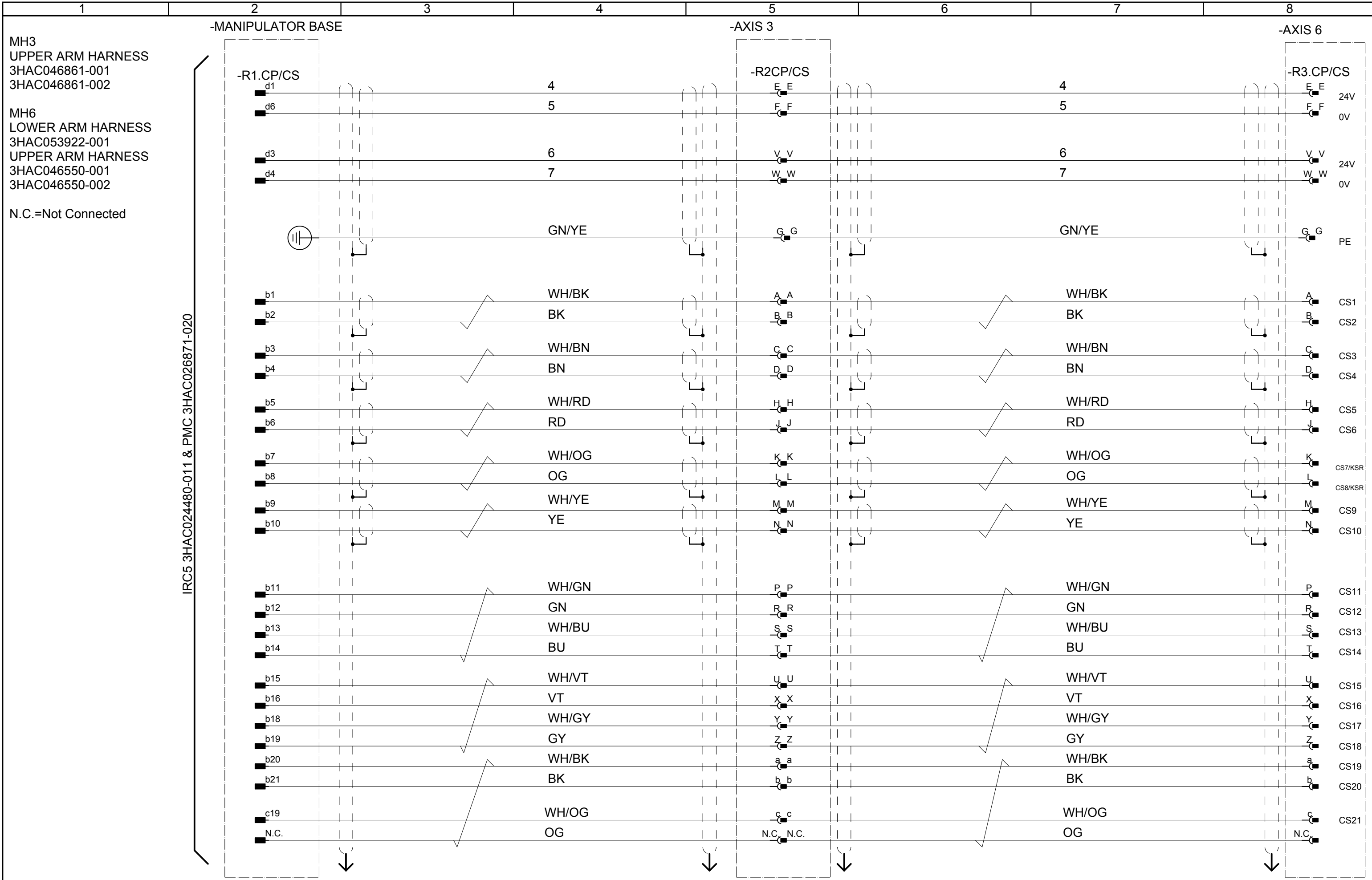

IRC5 3HAC024480-011 & PMC 3HAC026871-020

Latest revision: ECO 105331, WI 241451
Pg 50-55: Functional earth added.
Pg 104-105; 155-157; 204-205: New harnesses added, including functional earth.

Prepared by, date: EM 2019-06-26 Approved by, date: ML 2019-08-14

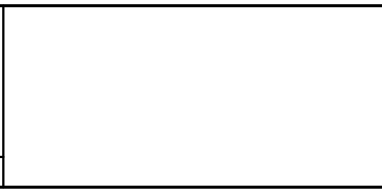

Lab/Office: RARO SE RDM2

IRB6650S, IRB7600 LeanID

PARACOM MH3 & 6

TYPE H

Status: 2019-08-14

Plant: = DP
Location: + H
Sublocation: + AX3

Approved

Document no. 3HAC022327-002

Rev. Ind 01

Page 200
201
Total 31

We reserve all rights in this document and in the information contained therein. Reproduction, use or disclosure to third parties without express authority is strictly forbidden. © Copyright 2003 ABB

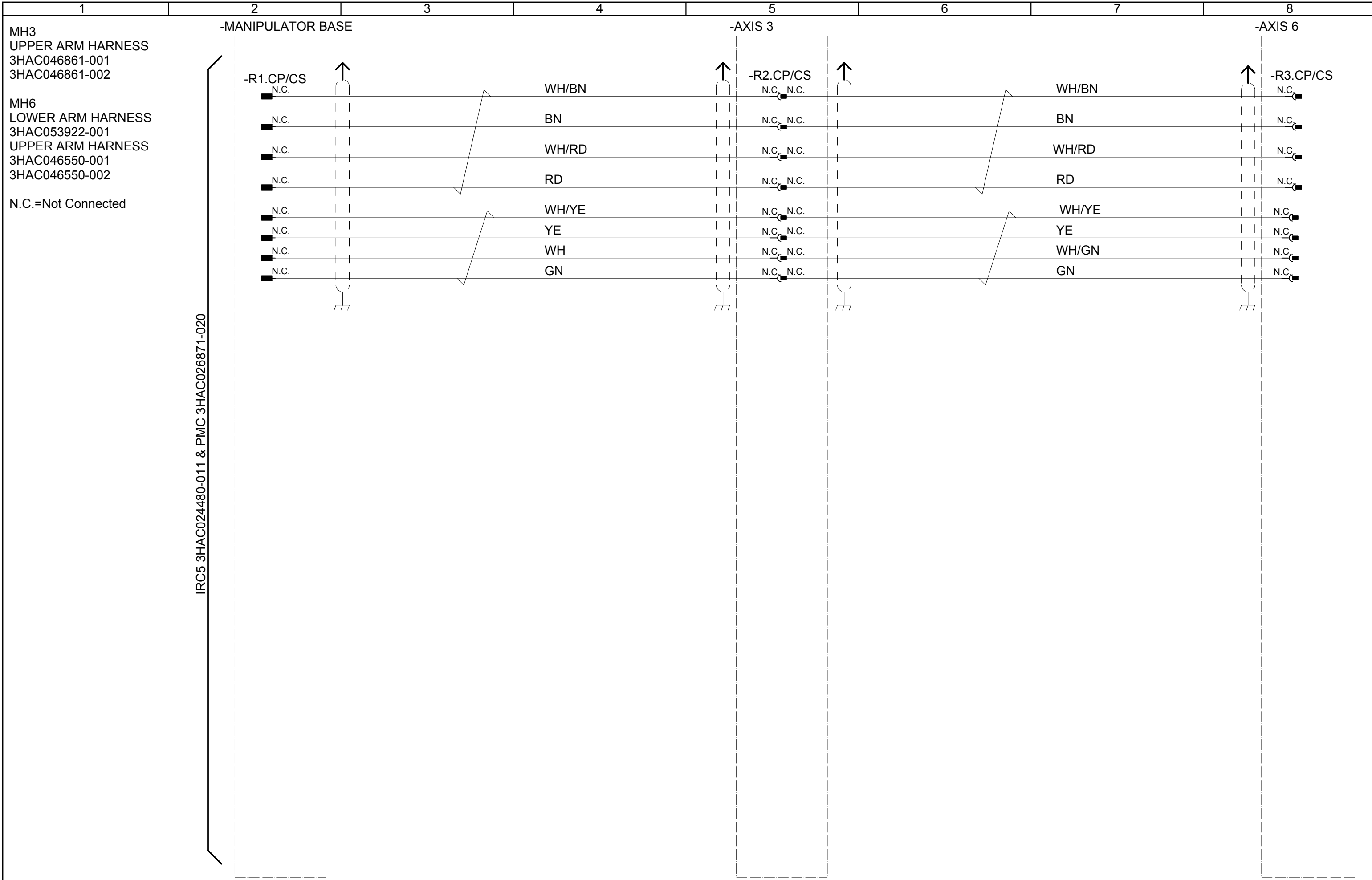

Latest revision: ECO 105331, WI 241451
 Pg 50-55: Functional earth added.
 Pg 104-105; 155-157; 204-205: New harnesses added, including functional earth.

Prepared by, date: EM 2019-06-26 Approved by, date: ML 2019-08-14

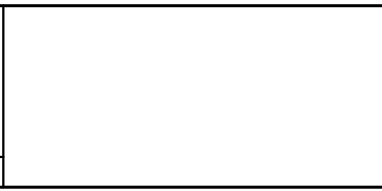

Lab/Office:
 RARO SE
 RDM2

IRB6650S, IRB7600 LeanID
 PARACOM MH3 & 6
 TYPE H

Status: 2019-08-14
 Approved
 Document no. 3HAC022327-002

Plant: = DP
 Location: + H
 Sublocation: + AX3

Rev. Ind 01
 Page 201
 Total 31

We reserve all rights in this document and in the information contained therein. Reproduction, use or disclosure to third parties without express authority is strictly forbidden. © Copyright 2003 ABB

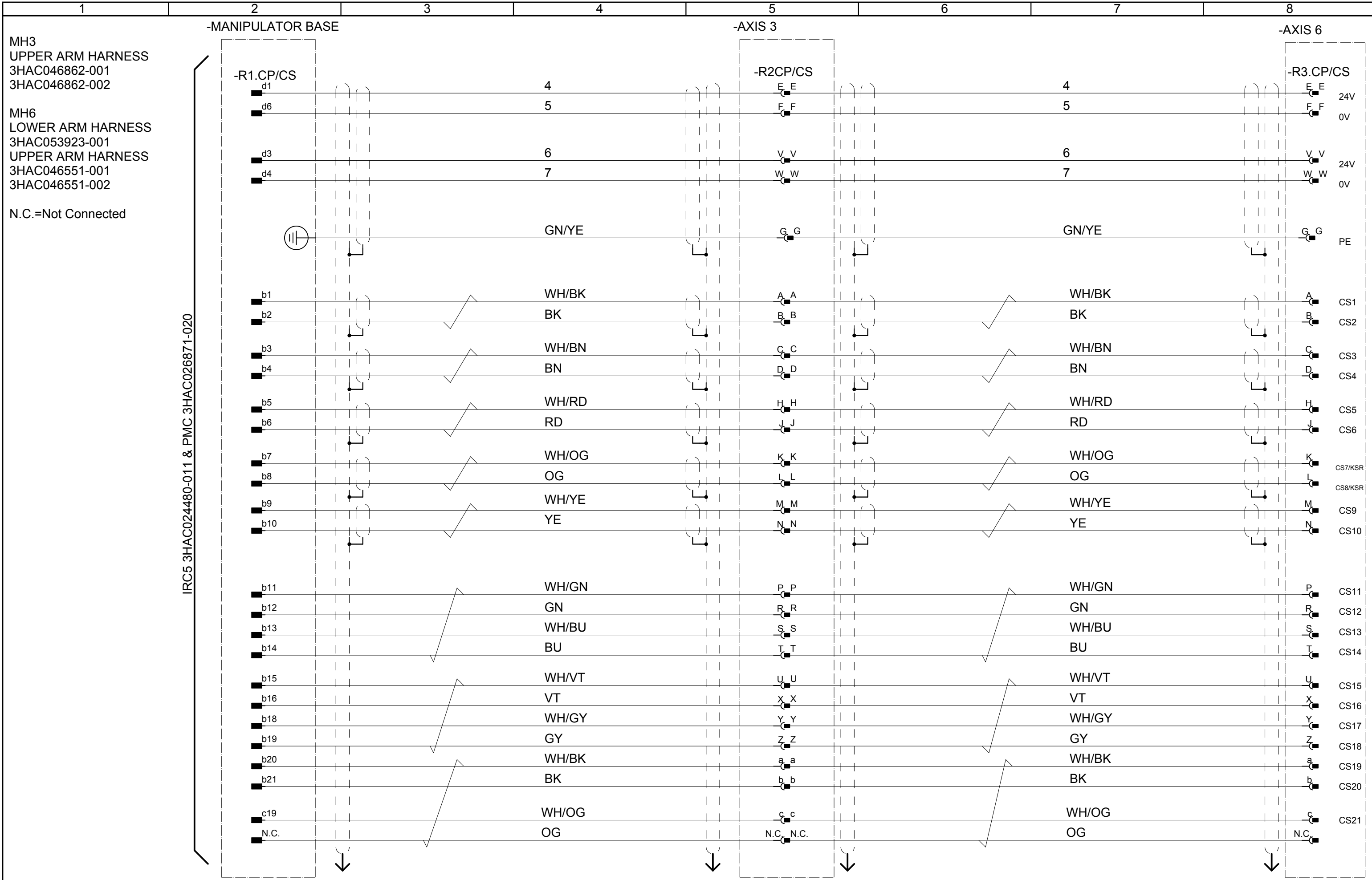

Latest revision: ECO 105331, WI 241451
 Pg 50-55: Functional earth added.
 Pg 104-105; 155-157; 204-205: New harnesses added,
 including functional earth.

Prepared by, date: EM 2019-06-26 Approved by, date: ML 2019-08-14



Lab/Office:
 RARO SE
 RDM2

IRB6650S, IRB7600 LeanID
 PARABUSCOM MH3 & 6
 TYPE H

Status: 2019-08-14
 Approved
 Document no. 3HAC022327-002

Plant: = DP
 Location: + H
 Sublocation: + AX3

Rev. Ind 01
 Page 202
 203
 Total 31

We reserve all rights in this document and in the information contained therein. Reproduction, use or disclosure to third parties without express authority is strictly forbidden. © Copyright 2003 ABB

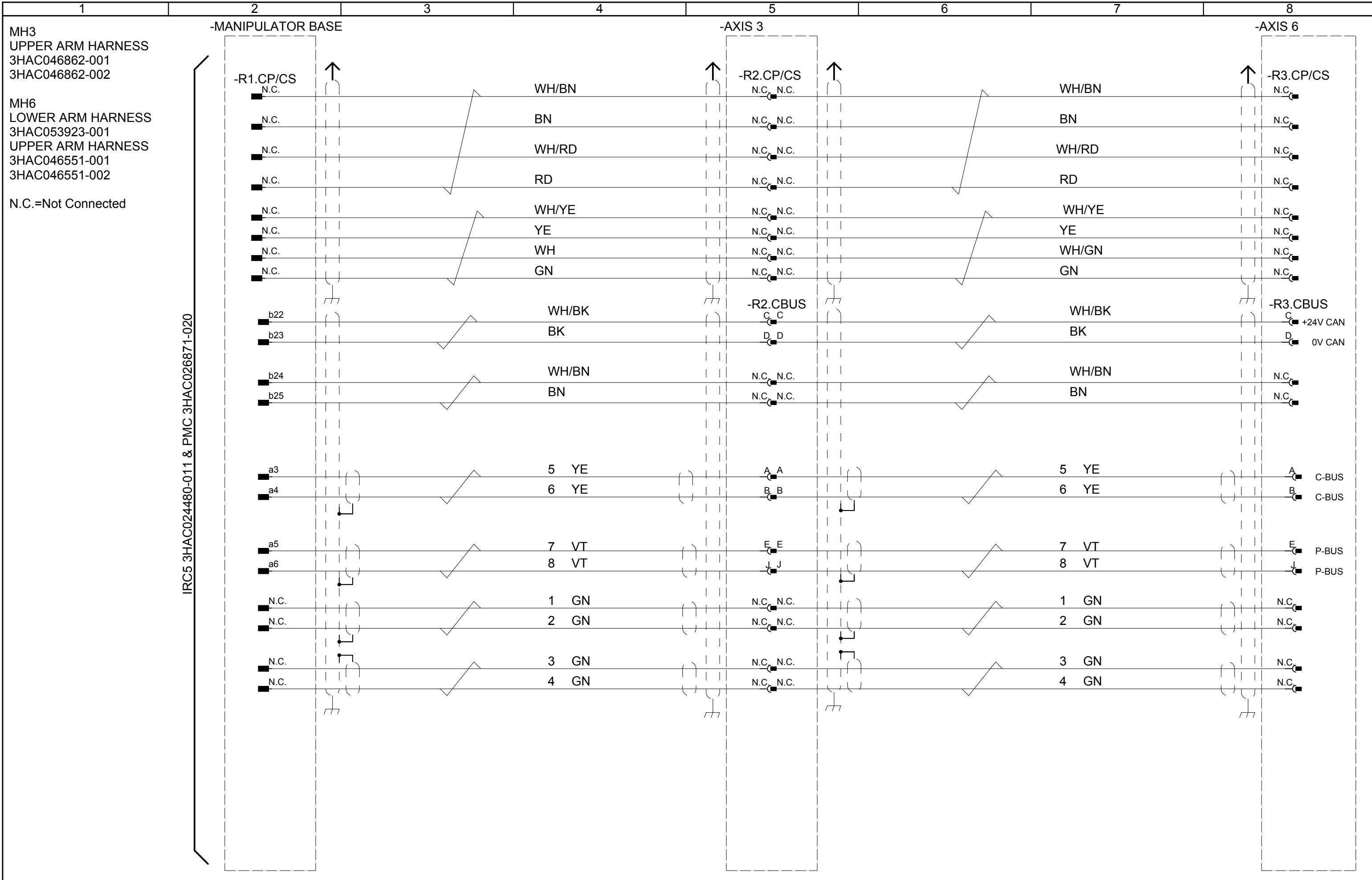

Latest revision: ECO 105331, WI 241451
 Pg 50-55: Functional earth added.
 Pg 104-105; 155-157; 204-205: New harnesses added, including functional earth.

Prepared by, date: EM 2019-06-26 | Approved by, date: ML 2019-08-14

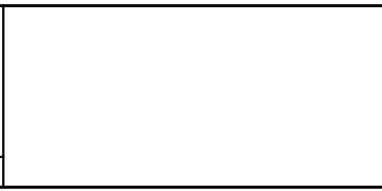

Lab/Office: RARO SE RDM2

IRB6650S, IRB7600 LeanID

PARABUSCOM MH3 & 6

TYPE H

Status: 2019-08-14

Plant: = DP
 Location: + H
 Sublocation: + AX3

Approved

Document no. 3HAC022327-002

Rev. Ind 01

Page 203
 204
 Total 31

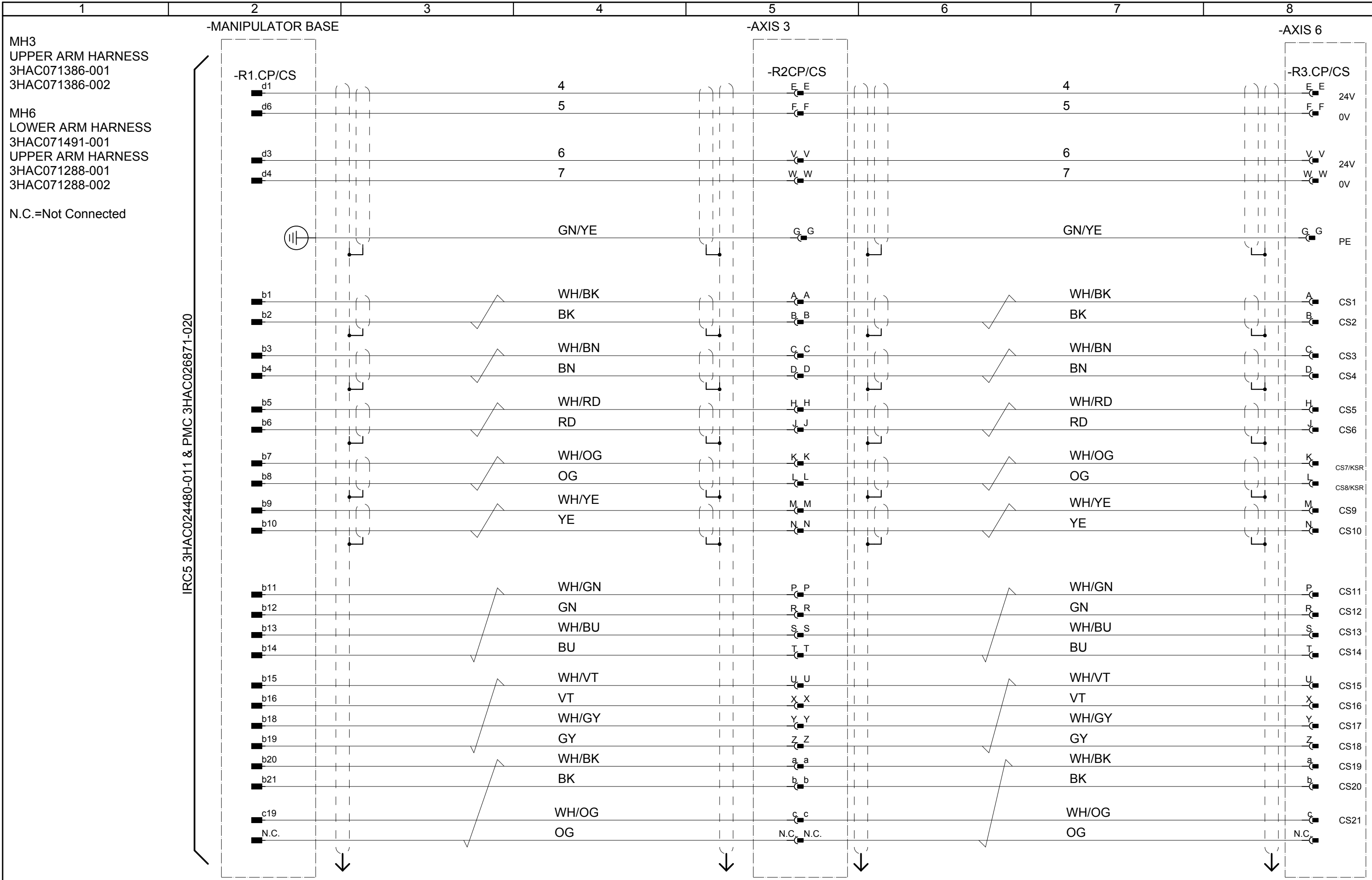

Latest revision: ECO 105331, WI 241451
 Pg 50-55: Functional earth added.
 Pg 104-105; 155-157; 204-205: New harnesses added,
 including functional earth.

Prepared by, date: EM 2019-06-26 | Approved by, date: ML 2019-08-14

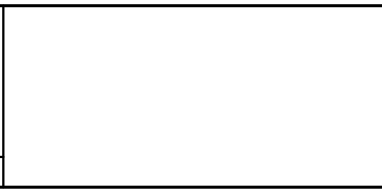

Lab/Office:
 RARO SE
 RDM2

IRB6650S, IRB7600 LeanID

PARAMULTI MH3 & 6

TYPE H

Status: 2019-08-14

Plant: = DP
 Location: + H
 Sublocation: + AX3

Approved

Document no. 3HAC022327-002

Rev. Ind 01

Page 204
 205
 Total 31

We reserve all rights in this document and in the information contained therein. Reproduction, use or disclosure to third parties without express authority is strictly forbidden. © Copyright 2003 ABB

We reserve all rights in this document and in the information contained therein. Reproduction, use or disclosure to third parties without express authority is strictly forbidden. © Copyright 2003 ABB

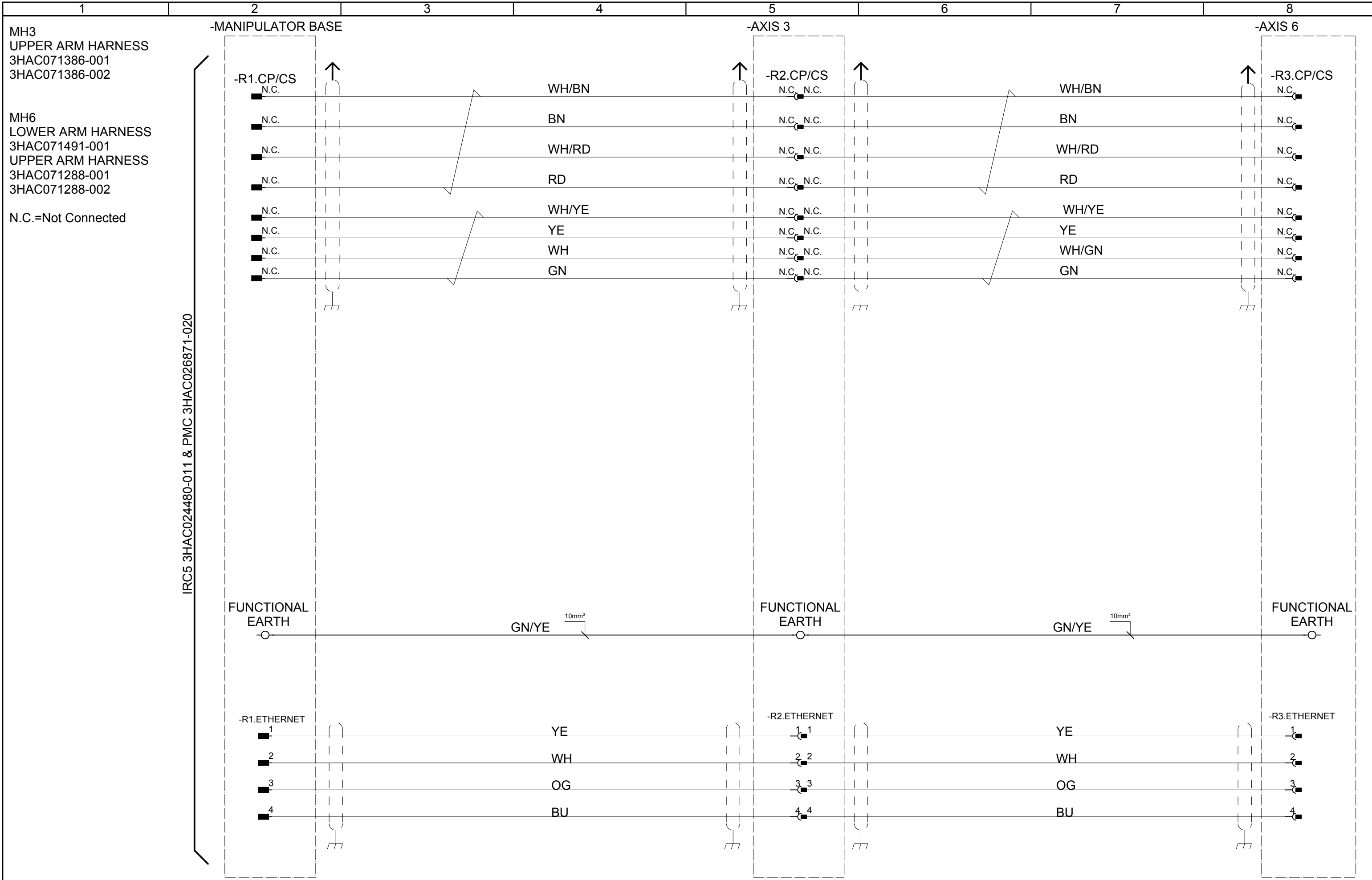

Latest revision: ECO 105331, WI 241451
Pg 50-55: Functional earth added.
Pg 104-105; 155-157; 204-205: New harnesses added, including functional earth.

Prepared by, date: EM 2019-06-26 | Approved by, date: ML 2019-08-14

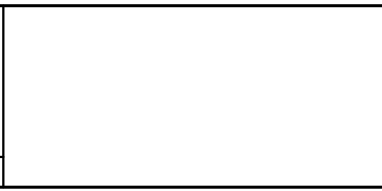

Lab/Office:
RARO SE
RDM2

IRB6650S, IRB7600 LeanID
PARAMULTI MH3 & 6
TYPE H

Status: 2019-08-14
Approved
Document no. 3HAC022327-002
Plant: = DP
Location: + H
Sublocation: + AX3
Rev. Ind 01
Page 205
+PG/250
Total 31

We reserve all rights in this document and in the information contained therein. Reproduction, use or disclosure to third parties without express authority is strictly forbidden. © Copyright 2003 ABB

TYPE HSe
 RESOLVER SIGNALS
 VALID FOR
 FLOOR HARNESS
 3HXD1250-70
 LOWER ARM HARNESS
 3HAC023278-001

-SERVO PEDESTAL GUN
 (AXIS 7)

-MANIPULATOR BASE

-SMB

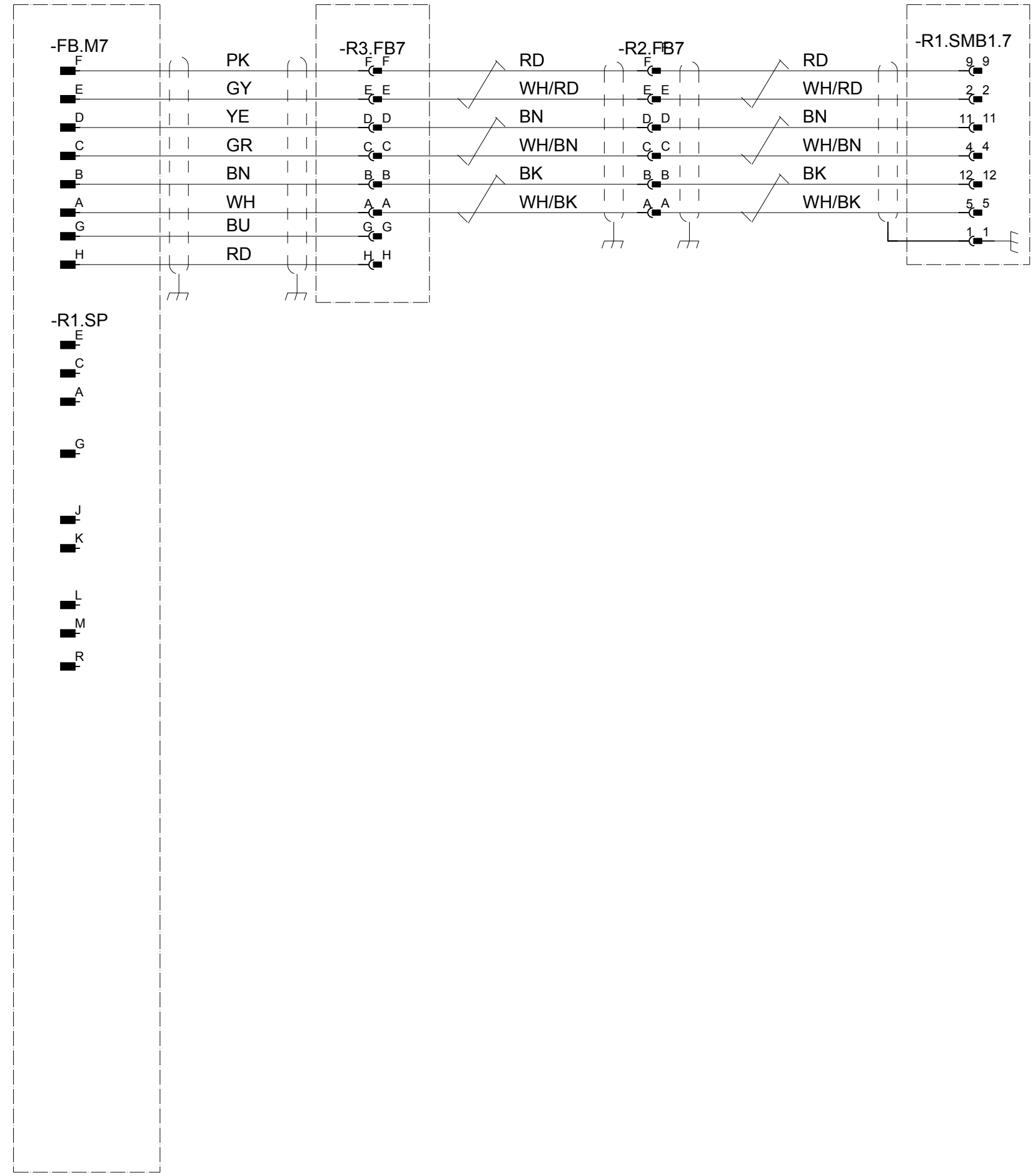

Latest revision: ECO 105331, WI 241451
 Pg 50-55: Functional earth added.
 Pg 104-105; 155-157; 204-205: New harnesses added,
 including functional earth.



Lab/Office:
 RARO SE
 RDM2

IRB6650S, IRB7600 LeanID

PEDESTAL GUN

TYPE HS, HSe

Status: 2019-08-14

Approved

Document no.

3HAC022327-002

Plant: = DP

Location: + PG

Sublocation: +

Rev. Ind

01

Page 250

Total 31

Prepared by, date: EM 2019-06-26

Approved by, date: ML 2019-08-14